

44th World Scout JAMBOREE

On the Air / Sur les Ondes

20 October
2001
21 octobre



World JOTA Report Rapport Mondial du JSLO



World Organization
of the Scout Movement
Organisation Mondiale
du Mouvement Scout

World JOTA Report

the story of the world-wide

44th Jamboree On The Air

20 - 21 October 2001



Each year in the third full weekend of October hundred-thousands of Scouts and Guides all over the world exchange greetings, learn about each others country and culture, swap programme ideas and make new friends. The contacts between them are established by amateur radio stations. This Jamboree-On-The-Air (JOTA) is the largest annual event for Scouts.

Chaque année durant le troisième week-end d'octobre, des centaines de milliers de Scouts et Guides dans le monde entier échangent des salutations, apprennent la culture des autres pays, se transmettent des idées de programme et se font des nouveaux amis, tout cela par contacts entre stations de radioamateurs. Ce Jamboree-Sur-Les-Ondes (JSLO) est la plus grande manifestation annuelle du Scoutisme. (Résumé français au chapitre 2).

Cada año, durante todo el tercer fin de semana de octubre, cientos de miles de scouts y guías de todo el mundo se envían saludos, aprenden acerca de otros países y culturas, comparten ideas para el programa y establecen nuevas amistades. Estos jóvenes toman contacto mediante estaciones de radioaficionados. El Jamboree en el aire (JOTA en inglés) es el acontecimiento scout anual más grande del mundo. (Resumen español en el capítulo 2).

Contents:

1	A new dimension	1
2	Résumé français / resumen español	2
3	Figures, numbers and facts	3
4	JOTA on the web	8
5	JOTA in print	10
6	Reports from countries	15
7	Kit corner	40
8	Forthcoming radio-scouting events	42
9	The 45 th JOTA	43
10	National JOTA Organizers	44

©2002.

World Organization of the Scout Movement, Geneva, Switzerland. All rights reserved. Member Scout Organizations may reproduce portions of the text for non-commercial use, with credits for its source.

Published by the World Scout Bureau. Publication number 1310.

1. A new dimension ..

A year with many changes is behind us. Just when you think you have "seen it all", something very surprising happens. In this case, it was a JOTA report that landed in my mailbox from ...outer space. The 44th JOTA will go into history as the one where a voice came out of a Space station calling "CQ Jamboree". The commander of the International Space Station, himself a former Scout, took part in the JOTA event, while he was in orbit at 310 km above us. He gave JOTA a new dimension.

The 44th Jamboree On The Air was held in the turbulent aftermath of the tragic events in the USA. What influence it had is unclear, but we did see a significant drop in total participants world wide. The Jamboree on the Internet organizers also reported a drop in activity with about half the previous year's visitors to the World Scouting web site.

Unfortunately the printed participation cards arrived in the post too late for many JOTA organizers to distribute. One reason was due to the fact that the World Scout Bureau was undergoing major building renovations in July and August. In the future we must depend even more on the opportunities for electronic communications.

On the positive side, the JOTA weekend was blessed with excellent radio conditions. HF bands stayed open most of the night, depriving many operators from some hours of sleep. Since who wants to go to bed when there are still Scout stations you can contact? Several countries reported solid, long-distance contacts. In some cases high quality colour pictures were exchanged by radio too.

And for those that could not use the favorable radio conditions, there was the experiment with IRLP; a technique where the radio signal is transported by a piece of internet for part of the way. Could yet another dimension evolve from this: Jamboree On The InterAir..?

Before you is the story of the 44th Jamboree On The Air. In fact, it is not one story, but maybe half a million stories. Each Scout will have his or her own recollection of the event: living the adventure, soldering an electronic gadget, making new friends. Some of these stories have been reported for you by the participants and you will find their adventures in this booklet.

Have a taste of the international flavour of World Scouting. Happy reading!

Richard Middelkoop, PA3BAR
Editor
15 January 2002



2. Résumé français / resumen español

Une année de grands changements vient de s'écouler. Et quand vous croyez avoir tout vu, quelque chose vient encore vous surprendre. Je fais allusion à un rapport JOTA qui s'est retrouvé dans ma boîte à lettres et qui provenait de l'espace. Le 44e JOTA restera dans les annales pour avoir entendu, venant d'une station de l'espace, une voix qui appelait "CQ Jamboree". En effet, le commandant de la Station internationale de l'espace, un ancien scout, a pris part au JOTA alors qu'il était sur orbite à 310 km au-dessus de nos têtes. Cela donne au JOTA une nouvelle dimension !

Le 44e Jamboree-sur-les-Ondes s'est déroulé dans des moments troublés après les événements tragiques survenus aux Etats-Unis. En quoi cela a-t-il pu influencer le déroulement de l'événement, ceci n'est pas très clair. Ce qui est certain c'est que le nombre total de participants à l'échelle mondiale a chuté spectaculairement. Cette année les organisateurs du Jamboree-sur-Internet ont aussi enregistré pendant le JOTI la moitié moins de visites du site web du Scoutisme que l'année précédente.

Malheureusement, les cartes de participation envoyées par la poste sont arrivées dans plusieurs cas trop tard pour que les organisateurs du JOTA puissent les distribuer à temps. Ce retard est dû en partie aux importants travaux de rénovation du bâtiment du Bureau Mondial du Scoutisme entrepris pendant les mois de juillet et août. A l'avenir nous devrions exploiter encore davantage les opportunités qui s'offrent à nous dans le domaine des communications électroniques.

D'un autre côté, et cela est très positif, le week-end du JOTA a bénéficié de conditions radio excellentes. Les bandes HF sont restées ouvertes la plus grande partie de la nuit, privant de sommeil de nombreux opérateurs. Car qui aurait voulu aller au lit alors qu'il était encore possible de contacter des stations scouts ? Plusieurs pays ont rapporté qu'ils avaient eu des contacts sur de très longues distances. Dans certains cas des photos couleurs de grande qualité ont même pu être échangées par radio.

Et pour ceux qui n'ont pas pu bénéficier de ces excellentes conditions radio, la possibilité de se familiariser avec l'IRLP - une technique qui permet de transporter par Internet le signal radio pour une partie de la distance à couvrir - leur était offerte. Est-ce que cela pourrait également déboucher sur une nouvelle dimension comme le Jamboree-Inter-Ondes par exemple ?

Dans les pages qui suivent vous trouverez l'histoire du 44e Jamboree-sur-les-Ondes. En fait il ne s'agit pas d'une histoire mais d'un demi-million d'histoires quasiment. Chaque scout (e) a de l'événement un souvenir qui lui est propre : l'aventure vécue, la réalisation d'un gadget électronique, s'être fait de nouveaux amis. Quelques-unes de ces histoires sont relatées par les participants qui vous invitent à partager leurs aventures dans ce livre.

Presque tous les rapports nationaux du JOTA ont été envoyés électroniquement, ce qui a rendu le travail d'édition beaucoup plus aisé et rapide. La communication électronique va prendre une place de plus en plus importante dans l'organisation du JOTA : au lieu d'imprimer des circulaires d'information, le Bureau Mondial du Scoutisme les mettra en ligne. Seule la circulaire du mois d'août sera imprimée sur papier et envoyée avec les cartes de participation.

Au Chapitre 4 vous trouverez une brève introduction des informations JOTA disponibles sur le Web. Les histoires détaillées par pays sont présentées au chapitre 6. Dans le dossier de projet de cette année, sous le chapitre 8, vous trouverez une boussole électronique spectaculaire. Enfin, le logo du 45e JOTA est révélé dans le chapitre 9.

Je vous invite par ces lignes à avoir un avant-goût du Scoutisme Mondial. Bonne lecture!
!

Un año más de muchos cambios está detrás de nosotros. Justo cuando piensas que "todo lo has visto" entonces algo sorprendente sucede. En este caso, fué un reporte de JOTA que llegó a mi mailbox (sitio de direcciones) de la parte de espacio. El aniversario 44 de Jota será recordado en la historia por una voz que vino de una estación espacial llamando "CQ Jamboree". El comandante de la estación espacial internacional, un verdadero Scout, tomó parte en el evento JOTA mientras estaba en órbita a 310 Km de altura. Esto dió una nueva dimensión a JOTA.

El aniversario 44 de Jamboree en el Aire tuvo lugar en una turbulencia de trágicos sucesos en los Estados Unidos. La influencia que tuvo no es muy exacta pero con certeza vimos una caída considerable de participantes de todo el mundo. Para los organizadores del Jamboree en internet también hubo una baja de actividades, casi cerca la mitad de visitantes con respecto del año anterior en el web-site de la Organización Mundial del Movimiento Scout.

Desafortunadamente las invitaciones impresas de participación llegaron en el correo demasiado tarde para que los organizadores de JOTA pudieran distribuirlos. Esto se debió a que la Oficina Scout Mundial estaba en plena renovación durante los meses de Julio y Agosto. En el futuro debemos aprovechar mas las oportunidades de la comunicacion electrónica.

El lado positivo, el fin de semana JOTA fué aventurado por excelentes condiciones de radio, las bandas HF estuvieron abiertas durante la noche, privando a muchos operadores de sus horas de sueño. ¿Desde cuando se puede ir a la cama cuando hay todavía estaciones de Scouts para establecer contactos? Muchos países se reportaron firmemente, contactos de larga distancia. También en algunos casos fotos en color de alta calidad fueron intercambiadas vía la radio.

Para aquellos que no pudieron utilizar las buenas condiciones de la radio, hubo el experimento IRLP, técnica con la cual la señal de radio es transportada con ayuda del internet en una porción del camino. Se evolucionaría otra dimensión: Jamboree en el Inter-Aire ...?

Ante ustedes, se encuentra la historia del Aniversario 44 de Jamboree en el Aire. De hecho, no es solamente una historia, sino quizás medio millón de historias. Cada hombre o mujer Scout tiene sus propios recuerdos de este evento: vivir la aventura, coleccionar tarjetas electrónicos, hacer amigos. Algunas de estas historias son contadas por los mismos participantes y pueden encontrar sus aventuras en este folleto.

Casi todos los reportes nacionales de JOTA fueron enviados electrónicamente, lo cual hace mas fácil y rápido, la edición de esta apreciación mundial. La comunicación electrónica va a jugar un papel muy importante para la organización de JOTA, en lugar de información con circulares vía escrita, la Oficina Scout Mundial dará a conocer los detalles de JOTA vía on-line. Es posible que todavía se envíe en Agosto la circular escrita con las tarjetas de participación.

En el capítulo 4 encontrarán una breve introducción para obtener informaciones acerca de JOTA las cuales son disponible en la Web. Las historias detalladas de cada país se encuentran en el capítulo 6, el capítulo 8 contiene el paquete del proyecto de construcción el cual es una brújula espectacular electrónica. El nuevo logo para el aniversario 45 de JOTA es revelado en el capítulo 9.

Esperamos que disfruten el sabor del Escultismo Mundial.
¡ Feliz lectura!

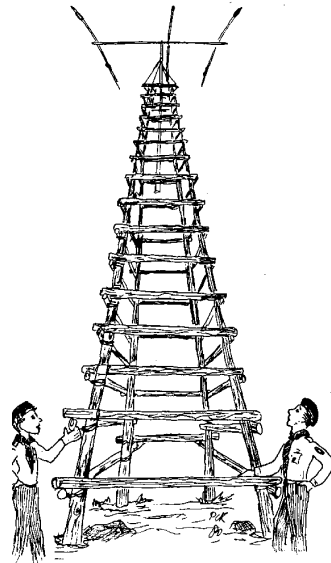

3. Figures, numbers and facts

The 44th Jamboree-On-The-Air enjoyed an enthusiastic worldwide participation. Our thanks go especially to those National JOTA Organizers and International Commissioners who have sent us the information of the JOTA in their country.

In this chapter, we have included statistics of JOTI participation as well. Merely to give you an idea of the interest in the growing use of internet technology during the weekend.

Scout amateur radio stations operated from the following countries for the 44th JOTA:

I	R		I	R		I	R		I	R	
3	1	Algeria	1	1	El Salvador		2	Madagascar		1	Singapore
3	6	Argentina	1	1	Fiji	*	32	<u>Malaysia</u>	*	10	27 <u>Slovakia</u>
*	10	43 <u>Australia</u>	6	13	Finland		3	13 Malta		2	6 Slovenia
*		32 <u>Austria</u>	10	16	France		2	1 Mauritius	*	7	7 South Africa
*		20 Azerbaijan	* 12	20	Germany	*	3	<u>Mexico</u>		9	16 Spain
		1 Bahrain	* 10	18	<u>Greece</u>		2	2 Morocco		1	Sri Lanka
5	12	Belgium	2	1	Guatemala	*	16	27 Namibia		1	1 St. Vincent
*	3	2 Bolivia			3 Guyana		2	Neth. Antilles	*	20	25 Sudan
		1 Bosnia			1 Haiti	*	5	42 <u>Netherlands</u>		1	2 Surinam
8	9	Brazil	1	2	Honduras	*	6	5 New Zealand		9	19 Sweden
2	2	Brunei	2	3	Hong Kong			1 Nicaragua		6	18 Switzerland
3	3	Bulgaria	2	8	Hungary	*		2 Nigeria		1	1 Syria
1		Cameroon	* 9	22	<u>Iceland</u>	*	32	20 <u>Norway</u>		2	1 Tanzania
*	46	28 <u>Canada</u>	4	6	India	*	29	46 <u>Oman</u>		4	2 Thailand
1	1	Central Afr. Rep.	* 8	8	<u>Indonesia</u>	*	16	6 <u>Pakistan</u>	*	3	4 Trinidad & Tobago
*		11 <u>Chile</u>	*		17 Ireland	*	16	6 <u>Panama</u>	*		25 Tunisia
4	5	China Rep.	3	4	Israel		2	Papua New Guinea	*	8	24 <u>Turkey</u>
4	5	Colombia	* 20	23	Italy		2	2 Paraguay		1	1 Uganda
4	4	Costa Rica	1	1	Jamaica		4	5 Peru		12	<Ukraine>
5	7	Croatia	* 11	15	Japan		7	4 Philippines	*	8	49 <u>United Kingdom</u>
*		17 Cyprus	1	2	Jordan	*		42 Poland	*		38 United States
3	12	Czech Rep.			2 Korea	*	36	19 <u>Portugal</u>		2	3 Uruguay
*	29	32 <u>Denmark</u>	4		Kuwait		2	6 Puerto Rico		2	7 Venezuela
1	1	Dominica	1	4	Latvia		4	11 Romania	*	62	World Bureau HB9S
2	2	Dominican Rep.	3	1	Lebanon		2	12 Russia		6	10 Yugoslavia
2	2	Ecuador			2 Liechtenstein		2	1 Saudi Arabia			1 Zambia
2	5	Estonia			2 Lithuania		2	1 Senegal		3	3 Zimbabwe
4	3	Egypt	* 2	4	<u>Luxembourg</u>						

Figure 1. Countries from which scout stations operated during the 44th JOTA.
 The number of other countries that were contacted is shown in front of a country's name, where "I" indicates contacts via internet and "R" contacts via radio.
 * indicates that a National JOTA Report is received and is quoted in chapter 6.
underlined indicates that non-licensed scouts are allowed to speak themselves.
 <country> indicates that the emerging Scout Organization is not yet a recognized WOSM member.

Figures, numbers and statistics. Do they really matter? Not to measure the fun that the Scouts had taking part in JOTA. Their JOTA stories on the next pages are a better indication of that. But to have an idea of the extend of the JOTA weekend, figures can be helpful. E.g. to convince your supporters that the JOTA is the largest annual WOSM activity. The next three pages have all the numbers you may need for this.

Figure 2 shows the number of participating Scouts and Guides per country as a percentage of the total membership of Scouts and Guides (WOSM) and Guides (WAGGGS). For simplicity, beavers, cubscouts, scouts, rovers and explorers have all been regarded as "Scouts" and similarly for the girls. Using a relative number makes it easier to compare the participation in different countries. Please note that we have used a logarithmic scale in this graph. That means that both small and large numbers can be displayed in the same picture. In comparing them, please read the scale numbers. JOTA is not a competition and these figures merely indicate that there are differences in interest, organization and reporting in these countries. Local circumstances can vary quite a bit.

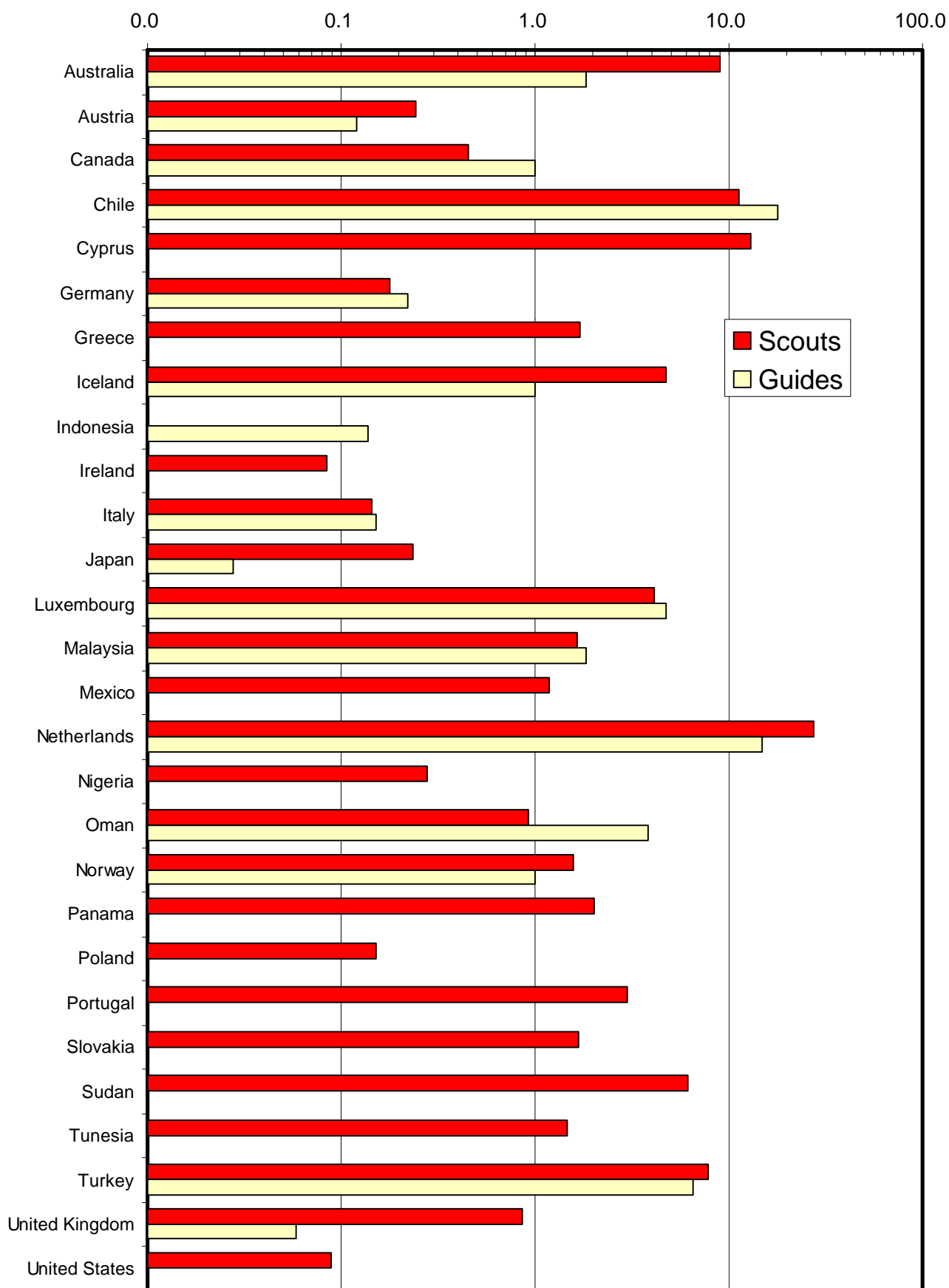

Figure 2. Percentage (%) of Scouts and Guides per country taking part in the JOTA.
(Note: logarithmic scale !)

	JOTA	JOTI
Scouts	259256	19321
Guides	89762	28344
total participants	349017	47665
JOTA radio stations		
radio amateurs	3704	
internet locations	11384	1278
visitors	128564	13507
active countries	108	82

Figure 3: Total participation in the 44th Jamboree-On-The-Air and Jamboree On The Internet.

To arrive at a reliable estimate of the total number of participants, some statistics are needed, since not all the countries have sent a JOTA report. These statistics are based on the average participation of the countries that did send a report (figure 2), on the membership number of each Scout or Guide Association and on the list of countries that were reported as being active in the event (figure 1). All this leads to the participation numbers presented in figure 3:

At a considerable number of stations, the use of internet was combined with the running of an amateur radio station. Compared to the 3704

amateur radio stations, there were 1278 internet-only stations: scout groups that took part in the JOTI event without using amateur radio. This is about the same as last year. Many more internet stations were active, all combined with amateur radio stations and this category is the one that grows the fastest. Figure 4 shows the activity of the participants: those that took part with amateur radio only, those with internet only and those Scouts that operated a mixed station. The "radio-only" stations still have a small majority, but decreased in the past three years from 71 % to 60 % to the current 55 %. The largest growth is in the mixed mode, from 22 % to 30 % to 33 % this year, whilst internet-only grew from 7 % to 10 % to 12 %.

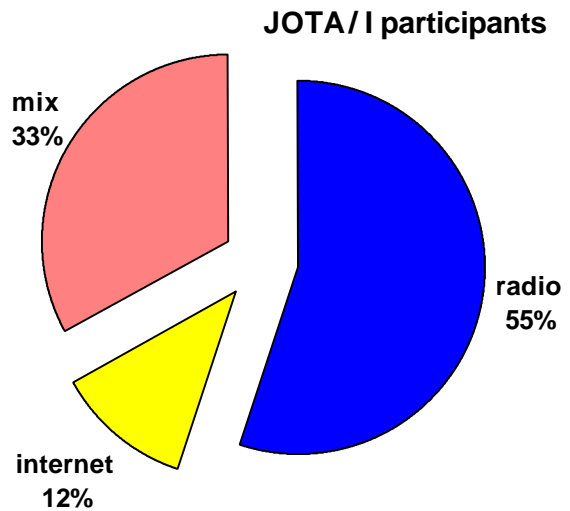

Figure 4. Division of JOTA / I participants.

As for the JOTA reports, the number of national JOTA organizers that sent theirs on a computer disk, via packet-radio or via email increased furthermore this year to a mere 82 % ! Have a

look at those numbers in figure 5. Electronic mail has certainly acquired its place. This allows electronic processing and saves a lot of time.

A report form was used in just 53 % of all the reports we received. This is the lowest ever since its introduction in 1989. The exact cause of this remains unclear: the 2nd JOTA circular, which was planned for August, did leave Geneva on time, but for some reason reached most National Organizers only just before the event. This circular also had the report forms. There was an electronic copy of the JOTA information put on the web site,

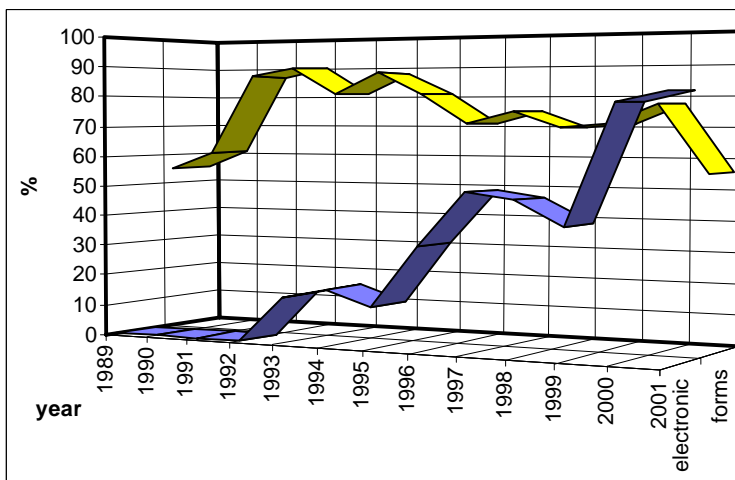

Figure 5. Percentage of reports sent electronically and reports containing a report form.

but not all NJO's were aware of this and it was apparently too late to be of any use to them. No doubt, the events of September 11 had another impact on the JOTA participation. The exact effect can only be guessed. However, we see quite a drop in total participation numbers. Figure 6 has the details.

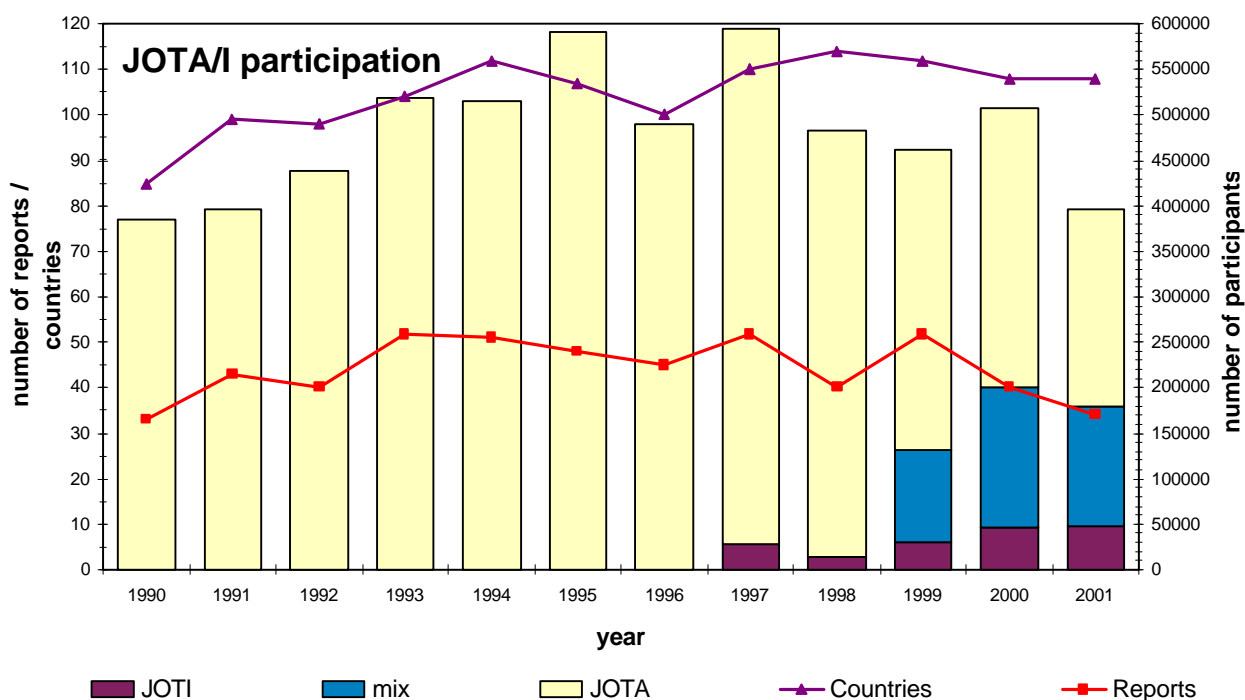

Figure 6: JOTA participation over the last decade.

The number of participants is shown as a column, related to the axis on the right hand side. The two lines show the number of countries involved and the number of National JOTA reports received by the World Scout Bureau. These lines correspond to the axis on the left-hand side.

A complete overview of 35 years JOTA history has been compiled by Len Jarrett, the former World JOTA Organizer: "The JOTA story, 35 years of Scouting's Worldwide Jamboree-on-the-Air". (This limited edition can still be ordered on line from www.worldscoutshop.org). From Len's book, we read the following:

40 years ago: the 4th JOTA, 21 - 22 October 1961.

The fourth JOTA is notable for the following report received from Japan; " I dearly present the report of all time- readability nil, strength nil- to you". Twenty-two National Organizers known to exist. World JOTA report issued for the first time.

25 years ago: the 19th JOTA, 16 - 17 October 1976.

"Terrible - the worst in 19 years of JOTA", said the World Report. This was supposed to be "Scout Communications Year", but no-one had thought to tell Mother Nature.

10 years ago: the 34th JOTA, 19 - 20 October 1991.

"Peace and Friendship through Communication", said the JOTA logo this year. Who would better understand the meaning of this than Scouts from Eastern European countries who now could take part in direct contact with Scouts in the rest of the world. And so they did. Scouts from the new organizations in Hungary and Czechoslovakia were on the air, as well as the many stations representing emerging Scout organizations in Poland, Romania, Ukraine, Yugoslavia and the Baltic States. A unique

opportunity to learn more about each other's way of life - without much expense, without having to travel very far, just to the nearest amateur radio station.

Other countries were there on the airwaves for the first time or back after years of absence. Close to one hundred countries in all. The JOTA letter game kept many of us busy during the weekend. On Sunday, we at HB9S listened in on a contact between a French and a British station engaged in swapping letters. Would the French Scouts trade an A and an M for a P and an S?



4. JOTA on the web

JOTA information is now available year-round on the radio-scouting web site. It is updated at regular intervals and offers National JOTA Organizers the possibility to download the information that they need at any convenient moment. As of 2002, the radio-scouting web site will be the main information source for JOTA organization:

www.scout.org/jota

A survey conducted last year learnt that 97% of all National JOTA Organizers has an internet access. This is not surprising, as NJO's are usually technically oriented; new communication facilities are readily available to them. After experimenting with it for the past two years, it has become clear that the web site fulfills a need: have JOTA information quickly available to a wide audience. The visits to the site have more than doubled in the past year and clearly reach a top in October. The received reports indicate that 65 % of all countries use the web site to get JOTA programme information.

It's therefore only a natural transition to make the electronic information channel the main one and reduce the printed materials. The three annual JOTA information circulars will be reduced to one (sent in August), whilst the web site will have all the JOTA details available 24 hours a day, to download at any given moment.

To note that Scout Associations can insist on receiving paper copies for their NJO's by notifying the World Scout Bureau. Until now, not one Association has indicated this; the question was asked in the survey last November.

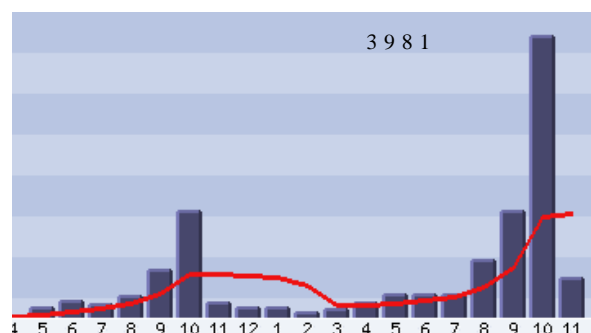

Radio-scouting web site accesses per month.

What is available on-line? A quick overview:

Latest news: shows amongst others, Scout camps and other activities with an amateur radio station on the air.

Library: General JOTA background material, JOTA programs, World JOTA Reports, useful technical tricks, web links to other program sources.

xxth JOTA, a section with all the details of the JOTA in a particular year, theme activities, annual participation card logo etc.

NJO Network, a separate section, only accessible to National JOTA Organizers registered at the World Scout Bureau. Annual JOTA report forms and other specific information is placed here. An email list to allow easy discussion amongst NJO's of whatever radio-scouting topic.

Alert emails, anyone interested in the subject can subscribe to this service, which automatically sends an email when new information is added to the web site has changed.

Skedbook service, where one can pre-arrange contacts between Scout radio stations.

The "first JOTA impressions" as they featured on the web site, shortly after the weekend:

Les Mitchell, G3BHK, founder of JOTA, United Kingdom:

JOTA really started for me on the late evening of Friday 19th. I heard Ian, GB4NDS working HB9S and I broke in and they kindly let me make this contact a three-way effort. So after this exciting start it was off to bed. At 0800 hrs on the 20th I joined the usual Scout net on 80m. About an hour later I called GB0SDS as I was visiting their station after lunch and wanted to deliver their QSL card by hand. I spent most of the afternoon at this station and what a wonderful effort they had organised. There was several other activity tables all concerned with some form of electronic pursuits and none of the youngsters seemed be able to find enough free time to become bored! A very good example of how to organise a really excellent JOTA weekend.

Next morning I started my hunt before breakfast and still in my pyjamas! I was hoping I might raise the odd VK Scout station but I fear I was probably a little late for these stations who were already very weak. However a YL/LA7IL was calling CQ Jamboree and not having any success, so I jumped in to discover it was an LA operator who had been at LC1J during the 1975 World Jamboree where I was a guest operator. So we had a long chat about LA Scout operators we both knew well and he explained to me that he worked for the Red Cross in many parts of the world and he always tried to get on the air for JOTA at whatever country he was in. He was presently located at Riga in Latvia. (I have since remembered that the last time we had spoken was over 20 years ago when he was in Israel.)

Beverly Viljoen, Guide Guider, Bulawayo, Zimbabwe:

I have just come back from spending the weekend at Gordon Park, Matopos, which is the campsite for the Matabeleland Province Boy Scouts of Zimbabwe. I had three guides from the 1st Girls College Guide Company, with me and they had a wonderful time, they had never been to JOTA before, and they could not believe us old JOTA goers when we said that we always had a natural disaster over this weekend (it nearly always rains). The Rover Scouts had several fun bases planned, such as abseiling, obstacle course, hikes, popcorn races, face painting etc. The radio hams only managed to get through to a few Jamboree Stations, mainly from South Africa, and of course our Scout Headquarters in Harare. We could hear two American stations, an English station, a Dutch station and a Japanese station, but when our radio operators tried to get through to them once they had finished, they had changed frequencies already. I have been attending JOTA on and off for the past 23 years and I would like to congratulate you and all the Scouts concerned with the excellent work that you do in planning and organising of JOTA. Many thanks



Len Jarrett, VE3MYF, former WJO, Canada

Well, that's the 44th JOTA over. Condx., particularly on 10 meters, seemed to be very good indeed. Biggest problem was QRM from the various contests going on - the DL one took up a lot of room and, here at least, there seemed to be quite a few K's on, too. Anyhow, I managed to improve my antenna and was able to get 5/9 from Norway, Belgium, U.K. and U.S.A. I did have a good QSO with K2BSA and, immediately after, heard GB2BSA and patiently queued up, only to have him say it was 5 o'clock and his supper was ready and so he was going QRT!

Nigel Rotherham, Group Scouter, 4th Benoni Air Scouts, South Africa

A total of 48 scouts (including girls) camped over the weekend and together with day visitors on the Saturday were able to enjoy a number of bases including amateur radio, Internet workstations, water activities (polo bats) commando course, orienteering course, electronics construction and a campfire on Saturday evening. I applied for a second call sign specifically for scouting camps. The call approved being ZS6BP! . The antennas were mounted on a 'crow's nest' pioneering mast approx 5M above ground built by the scouts. Eventually HF conditions improved (a little) and a number of contacts were made. The most remote being UA9KWB located just inside the arctic circle (Brrrrr!). Although several JOTA stations around the world were heard, we only managed to establish contact with two. ZS3KBS in Kimberly (20 m) and ZS2JAM in Port Elizabeth (15 m). At the close of camp, 44 cub's and scouts aged between 8 ~ 17 managed to earn the special JOTA badge and virtually every member of the camp staff chatted over the radio. Even the Area Commissioner paid us a visit and was able to talk with the station in Port Elizabeth!

5. JOTA in print

The JOTA is a major public-relations event for the Scout Movement as well. There is a large number of visitors that gets acquainted with JOTA and Scouting each year. The event also catches the attention of local and national authorities, as they are often asked to deliver the official national opening speech. Add all the media coverage of the JOTA to that and you have ample opportunity to promote Scouting.



10月20日-21日、第44回ワールドスカウト ジャンボリー オン ジェアおよびジャンボリーオン ジ インターネットが開催されます。昨年のジャンボリーオン ジ エアの報告によると108の地域と国のスカウト401,794人ガイド59,654人、JOTA無観局10,707局、ジャンボリー オン ジ インターネットには677の地域と国のスカウト37,848人ガイド8,208人が記録されています。今年もこの2日間に多くのスカウト・ガイドが参加の準備をすすめています。ぜひ、この行事に多くの参加を希望いたします。また、参加した場合はぜひ報告書を提出してください。

◀ 電子キット作りを楽しむスカウトとガイド

Ouverture du 44^e Jamboree mondial

Incontri Scout

M. Mohamed Triki, commissaire général du mouvement scout tunisien, a présidé, samedi à Borj Cédria, l'ouverture du 44^e Jamboree mondial en plein air.

Le commissaire général a effectué, à cette occasion, une communication sans fil avec le coordinateur général des pays arabes et le Brésil au sein de l'Union internationale. Il a mis en valeur l'importance de l'organisation de telles activités «qui sont de nature, a-t-il souligné, à familiariser les jeunes scouts avec les technologies de communication modernes». Il a souligné à cet égard la sollicitude du Président Zine El Abidine

Ben Ali pour la jeunesse tunisienne afin que sa voix soit entendue partout dans le monde.

A l'occasion de la célébration de cette manifestation internationale, le mouvement scout tunisien a organisé jusqu'au 21 octobre cinq rencontres scouts sur la radio amateur aux centres de Borj Cédria, Monastir, Thyna et Djerba.

Rappelons que le mouvement scout mondial organise annuellement ces rencontres avec la participation de 500.000 scouts qui communiquent entre eux par radio, pendant 24 heures sans interruption.

Scouts go high-tech

Skautské ideály spájajú svet

Slovenský skauting opäť v celosvetovej akcii Jamboree on the Air - na stretnutí v éteri cez rádiodamatérske vysieláče



Robert Koelewijn geeft uitleg over het zenden aan Franca (l.), Ron en Xander (r.).

Foto: Bert van de Pol

16e Jamboree On The Air

NIJKERK - Scoutinggroep Killaen van Rensselaar aan de Holkerweg deed afgelopen zaterdag mee aan het wereldwijde 'Jamboree On The Air'. De bedoeling van de JOTA is zoveel mogelijk contacten te leggen. De nadruk lag deze keer op de ouderwetse methodes als rooksignalen, telegrafie en morse. Ook werd gebruik gemaakt van het internet als communicatiemiddel.

Het gaat er allemaal zeer officieel aan toe, zoals de aanwezigheid van een hoofdzendamatéur, een hoge mast met een antenne en een leider bij iedere vier scouts. "In deze tijd van mobiele telefoons en e-mail weten veel kinderen eigenlijk niet meer hoe het

echte zenden gaat. Op een speelse manier leren wij de scouts hoe dit, nog niet zo heel lang geleden, allemaal ging.

We doen dit met licht- en rooksignalen, trommels, bekersjes met een touwtje er tussen en vele andere primi-

tieve communicatiemiddelen. Met onze zender hebben we vandaag contact gehad met Engelse, Duitse en natuurlijk Nederlandse scouts. Alleen in ons land doen er al 24.000 mee en over de hele wereld zelf meer dan een miljoen.

We kunnen best contact krijgen met Amerikaanse scouts, maar dan zijn we te lang bezig om verbinding te krijgen. Daarom zoeken we het wat dichterbij, dan hebben we veel meer contact", aldus Robert Koelewijn, een van de leiders.

Scout dal mondo all'abbazia

Raduno a Montecassino, attesi migliaia di ragazzi

Scout di tutto il mondo si ritroveranno sabato e domenica all'abbazia di Montecassino per il "44. Jamboree on the air", incontro via radio e su rete internet, organizzato dall'associazione guide e scout cattolici italiani (Agesci) della zona di Frosinone. «È un evento - dicono gli organizzatori - che ogni anno affascina e coinvolge sempre più i ragazzi e le ragazze di ogni parte del mondo utilizzando da qualche anno anche la rete internet. Per l'occasione il ministero delle telecomunicazioni concederà un nominativo speciale di stazione». La manifestazione Jota e Joti serve a scambiare le proprie esperienze e a condividere le loro idee con altri giovani di paesi diversi rafforzando il sentimento di fraternità mondiale insito nello scoutismo. Le guide e gli scout parteci-

panti potranno effettuare con i loro amici visite nel territorio e inoltre sarà predisposta una mostra filatelica tematica sullo scoutismo e l'attivazione di un servizio postale temporaneo e un annullo speciale concesso dall'ente poste. «Ogni anno - aggiungono gli organizzatori - il settore radioseout dell'associazione mondiale promuove iniziative collaterali con valenza educativa e formativa. Quest'anno l'interesse si è soffermato sull'utilizzo dell'energia elettrica e sarà presente con uno stand l'Eneb». Nella mattinata di sabato il centro scout di Montecassino sarà visitato dalle scolaresche della zona che potranno partecipare alle attività sulle tematiche dell'evento. Domenica mattina gli scout saranno ricevuti dall'Abate don Bernardo L'Onorio.



D. Tor.

Scout a Montecassino



JAMBOREE V ÉTERI

1000 rádiostanic zo 72 krajín. Minulý rok sa 43. ročníka JOTA zúčastnilo 532 000 skautov a skautiek pri 12 560 rádiostaniciach zo 117 krajín sveta. Na internete sa zúčastnilo 30 084 skautov na 808 staniciach.

Samozrejme, že veľmi dobrú spoluprácu máme so skautmi z českého Junáka, s ktorými sme prakticky pracovali na vlnách éteru ihneď po obnovení skautingu v Československu. Za český a slovenský skauting sme na Ústredie do Ženevy posielali i spoločné hlásenie. Národným organizátorom bol Miloš Nádeje z Prahy. Po rozdelení spoločného štátu na dva samostatné štáty Českú republiku a Slovenskú republiku som bol poverený Ústredím v Ženeve národným organizátorom JOTA pre Slovenský skauting ja a Slovensko dostalo i novú rádioamatérsku značku OM. Bývalá značka OK zostala Českej republike, národnou organizátorkou sa stala po zomrelom Milošovi Nádeje Hana Končická. Minulý rok vysielalo v ČR 32 rádiostanic, s väčšinou sme mali dobré spojenia. Je to výhoda pre začiatočníkov - skautov, že si môžu neobmedzene porozprávať o svojich aktivitách pre príbuznosť reči. Inak sa všeobecne korešponduje na JOTA v anglickom jazyku, ale je vítaná i nemčina, ruština, španielčina. Žasli by ste, koľko sa nám ozve našich krajanov zo zahraničia.

Bolo by účelné rozšíriť záujem o účasť skautov na JOTA a Internete po celom Slovensku. To sa nám bohužiaľ nedari, ale verím, že pri troche dobrej vôle by to išlo. Veď stačí sa porozhliadnuť najprv okolo seba, vo svojom meste, vo svojom okrese, že ochotných rádioamatérov, ktorí by pomohli skautom je stále dosť. Rádioamatéri sú predovšetkým "koničkári" a nadšenci pre svoju prácu, s ktorými si rýchlo porozumiete. Možno, že niektorých z nich poznáte osobne alebo býva vo vašom paneláku a rád vám

Πυρετωδώς προετοιμάζονται οι πρόσκοποι της Λαρίας για τη συμμετοχή τους στη μεγαλύτερη ετήσια διοργάνωση του Παγκόσμιου Οργανισμού της Προσκοπικής κίνησης το γνωστό JOTA - Τζάμπορη των Αιθέρων και JOTI Τζάμπορη στο Internet.

Το JOTA - JOTI πραγματοποιείται κάθε χρόνο και λαμβάνουν μέρος περισσότεροι από 1.000.000 Πρόσκοποι και Οδηγοί από κάθε γωνιά του πλανήτη οι οποίοι επικοινωνούν μεταξύ τους μέσω ερασιτεχνικών ραδιοφωνικών σταθμών ή με τη χρήση του INTERNET.

Το JOTA - JOTI είναι παγκόσμια δράση. Είναι ένα πραγματικό Τζάμπορη, κατά το οποίο Πρόσκοποι και Οδηγοί ανταλλάσσουν εμπειρίες και ιδέες, συμβάλλοντας στην εδραίωση της Παγκόσμιας Συναδέλφωσής μας.



650 Scouts, Girl Guides at jamboree

CAN YOU HEAR ME? ... Penang Girl Guides Association president Datin Su Hashim (seated second from right) talking on the ham radio at the 44th Jamboree-On-The-Air and Jamboree-On-The-Internet at Camp Coromation, near the Penang Botanic Gardens.

Assisting her was radio operator Ariff Karim from the Persatuan Radio Amatur

Melayu Utara Semenanjung Malaysia. Looking on were George Town North District Scout Commissioner R. S. Gurchuran Singh (seated left) and other committee members.

Su had tried her hand at communicating on the ham radio after closing the three-day jamboree, attended by about 650 Scouts and Girl Guides from schools in

the northern region, on Sunday.

She hoped that the participants would be able to share the valuable lessons and values learnt at the event with their school-mates.

The annual jamboree was to establish simultaneous radio and Internet contacts with about 500,000 Scouts and Guides worldwide.

Scouts de la región saldrán al mundo



ALBERTO CORTES/EL DIA

El director regional del Injap, Fernando Sermeño, junto a los organizadores del Joti y el Jota, los scouts Claudio Macailla y Black Cárdenas.

que tiene la actividad, y que busca no sólo compartir experiencias en común en torno al movimiento, sino que conocer otras realidades y compartir a partir de la diferencia.

Cabe destacar que el Jamboree Scouts Mundial por Internet es un encuentro que se realiza cada año el tercer fin de semana del mes de octubre, actividad oficial de la Organización Mundial del Movimiento Scout, en tanto el Jamboree en el Año mundial

este año su cuadragésimo cuarta versión.

Para todos aquellos que deseen participar del encuentro, y no lo hagan a través de las dependencias



Στη Θεσσαλονίκη οι εκπαιδευτικοί και οι μαθητές των σχολείων συμμετέχουν στο 44ο Jamboree Scouts Mundial por Internet. Στο εστιαγόμενο εστιαγόμενο των εκπαιδευτικών και των μαθητών που πραγματοποιήθηκε στο πλαίσιο του 44ου Jamboree Scouts Mundial por Internet.

المخيم الكشفي العالمي على الهواء

تشارك الكشافة التونسية مع جميع دول العالم في المخيم الكشفي العالمي الرابع والثلاثين على الهواء أيام 19 و20 و21 أكتوبر المقبل. ويهدف هذا النشاط إلى مزيد نشر هواية رانيد اللاسلكي في صفوف الكشافة وتدريبهم على استعمال وسائل الاتصال والتخاطب الحديثة وحذق المهارات التكنولوجية المتطورة. وحديثاً بالتذكير أن الكشافة التونسية سوف تنظم لهذا الغرض 3 ملتقيات كشفية للفتية والفتيات بمركز برج السورية والمنستير ومدينة وجدة حول مواقع

PERISIOTEROI anti duo epantimasi praxonta se oklino troi koto epantimasi mezu boronim kupton

Διεθνείς για ένα 48ωρο οι πρόσκοποι της Θεσσαλονίκης

Πολλοί εκπαιδευτικοί και μαθητές των σχολείων συμμετέχουν στο 44ο Jamboree Scouts Mundial por Internet. Στο εστιαγόμενο εστιαγόμενο των εκπαιδευτικών και των μαθητών που πραγματοποιήθηκε στο πλαίσιο του 44ου Jamboree Scouts Mundial por Internet.

ΣΩΜΑ ΕΛΛΗΝΩΝ ΠΡΟΣΚΟΠΩΝ

A. Οι πρόσκοποι Νάουσας σας καλούν το Σαββατοκύριακο 20-21 Οκτωβρίου στη Λέσχη τους (Μιχ. Λογίου) να επικοινωνήσουμε όλοι μαζί μέσω του INTERNET (διαδίκτυο) με προσκόπους και άλλα παιδιά από όλες της χώρες του κόσμου, στις ώρες 11 πμ έως 7μμ.
B. Σας πληροφορούμε επίσης ότι αρχίσαμε ήδη τη νέα προσηκοπική περίοδο και γίνονται εγγραφές κάθε Σάββατο στη Λέσχη, ώρες 12-2.30μμ
Από την Τοπική Εφορεία Προσκόπων Νάουσας

Mouvement scout
44^{ème} jamborée mondiale
A l'occasion de la célébration du 44^{ème} jamborée mondial en plein-air, le Mouvement scout tunisien organise les 19, 20 et 21 octobre courant, cinq rencontres scouts sur la radio amateur aux centres de Borj Cédria, de Monastir, de Thyra et de Djerba.
Ces rencontres ont pour objectif de mieux faire l'utilisation de la radio amateur entre les scouts et à les former à maîtriser davantage les technologies modernes de communication.
Rappelons que le Mouvement scout organise annuellement ces rencontres avec la participation de 500 mille scouts qui communiquent entre eux, par radio, pendant 24 heures sans interruption. (TAP)

Domani e domenica a Montecassino la 44^a edizione «Jota»

World scout in abazia

Le «guide» si confronteranno sui temi d'attualità

LA quantaquattresima edizione del «Jota» si svolgerà presso l'Abbazia di Montecassino, nei giorni di domani e domenica.

No, non stiamo parlando di un episodio di Guerre stellari, infatti «Jota» sta per Jamboree on the air, ovvero l'incontro via radio degli scouts radioamatori di tutto il mondo.

La manifestazione costituisce un vero e proprio avvenimento per gli scout che lo chiamano «Jamboree» come l'incontro reale che si svolge ogni quattro anni. Il Jota si tiene ogni anno nel terzo week end del mese di ottobre e vi partecipano in media più di cinquecento mila scouts e guide. Attraverso centri sparsi in tutto il mondo e, grazie alle radio amatoriali e tecnologie affini, questi ragazzi comunicheranno tra loro oltrepassando ogni frontiera.

L'evento è stato organizzato dal settore radio scout

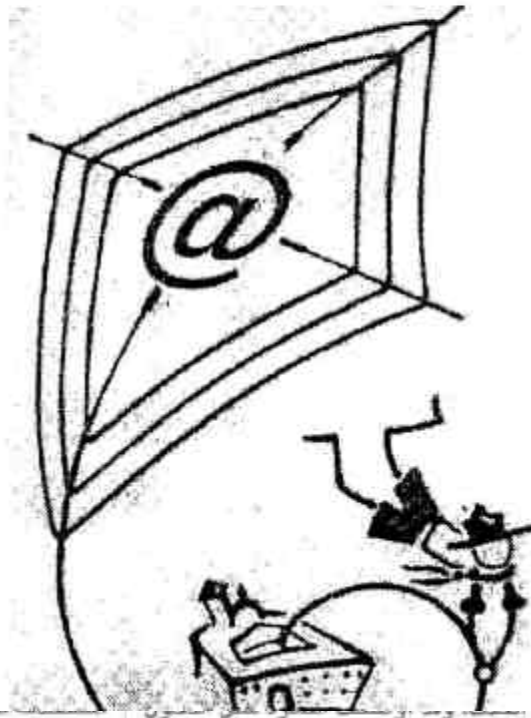

على الحروف اللاتينية الاولى المختصرة الى موقع المنظمة الكشفية العالمية على شبكة الانترنت والخطوات المؤدية الى اجراء لاسم المخيم الكشفي العالمي (on-The-Air)

السلطنة استضافت أول مخيم كشفي عربي على الهواء عام ١٩٩٣



Krátko z histórie

JOTA - Jamboree on the Air - stretnutie skautov vo vzduchu vzniklo v roku 1958 pod patronátom svetového skautského ústredia. Tradíciu založili skauti - rádioamatéri na Svetovom Jamboree v Anglicku v roku 1957, keď založili úplne prvú skautskú rádioamatérsku stanicu pod vedením anglického skauta a rádioamatéra Leslie Mitchella a volacou značkou G3BHK. Vtedy tiež vznikol nápad, aby sa skauti stretávali na rádiových vlnách každý rok v tretí októbrový víkend a pínili tak heslo: "Skautské ideály spájajú svet." JOTA si vytýčila úlohy - sprostredkovať stretnutia pre všetkých, ktorí nemajú možnosť vycestovať za hranice svojej zeme, vymieňať si pozdravy, nadväzovať priateľské kontakty a počúvať hlasy trebárs i z opačnej strany zemegule a zaujímavou formou približovať mladým ľuďom tak zložitý odbor ľudskej činnosti, ako je rozhlasová a televízna elektronika.

القومية في السلطنة كانت في تلك الوقت الجمعية الكشفية العربية الوحيدة التي تشارك في هذا الحدث العالمي وتابع قائلاً في عام ١٩٩٣ م رأت الهيئة ان تتوسع في مشاركتها، ايضاً منها باهمية نقل تجربتها الى شقيقاتها الجمعيات الكشفية العربية الأخرى - فتمت استضافة المخيم الكشفي العربي الأول على الهواء، مع اكنا للمخيم الكشفي العالمي السادس والثلاثين، وقد كان مخيماً ناجحاً، انطلقت فيه الأصوات الكشفية العربية من موقع مخيم السلطان قابوس الكشفي بالمدة، مستخدمة أحدث وسائل الاتصالات، ومن ثم بدأت فكرة مشاركة الجمعيات الكشفية العربية تنتشر شيئاً فشيئاً، وفي العام التالي، وبالتحديد في المخيم الكشفي العالمي السابع والثلاثين، كانت هناك - ايضاً - مشاركة ايجابية لكشافة ومرشدات السلطنة الثمرت عن حصول الهيئة القومية على شهادة تقدير من المنظمة الكشفية العالمية لأفضل تقرير مقدم على المستوى العالمي.

خامس مرة انترنت

واشار مساعديه ان مشاركة الهيئة لم تقتصر على مجرد المشاركة في مخيم الناصري بل شاركت ايضاً في المخيم الكشفي العالمي الرابع على شبكة الانترنت، وهذه هي المشاركة الخامسة للهيئة في هذا النشاط حيث سيتم خلال المخيم تبادل العديد من الرسائل عبر الشبكة الدولية مع العديد من الجمعيات الكشفية العالمية.

استعدادات مبكرة

وقال مساعدها دأبت الهيئة القومية على الاستعداد لهذا الحدث

6. Reports from countries

Note:

Indicated per country you will find the numbers of participants, of JOTA radio stations, of internet-only stations **not** using amateur radio and the number of different countries that were contacted. A question mark "?" indicates that the numbers were not given in the report.

Australia (VK)

participants:	11500
stations:	267
internet:	145
countries:	43

This year saw a lot more publicity throughout the year using traditional and innovative means. An E-Scouting article in each month's edition of the magazine *Australian Scout* showcased JOTA and JOTI and the use of the internet and radio in support of the youth program, writes

Stephen Watson.

Changes to participation trends were: a significant reduction in amateur radio operators available to support JOTA stations, an increase in JOTI activity, a decrease in JOTA-only stations, and a significant reduction in support and participation by Guides Australia.



Most favorite activities:

SSTV - Using the program MMSSTV, it is easy to send colour photos quickly. The program uses the computer's soundcard. A lot of fun, a conversation starter, holds Scouts interest, photos can be real time using a digital camera or webcam. It uses SSB, enabling conversation between images.

Kit building - An excellent on-site activity.

Demolition - Hours of fun. Surplus and junk electrical equipment, some tools, some Scouts. Scouts will destroy/dismantle the junk and scavenge any useful bits and pieces. Electric motors and fans can be shown to work by connection to radio power supply or battery.

Computer Building - Assemble a computer, including the inside parts, and get it up and running. Expert assistance, instruction, and supervision required. A great learning experience.

We welcomed a new Chief Scout this year and his support of JOTA through his participation for the

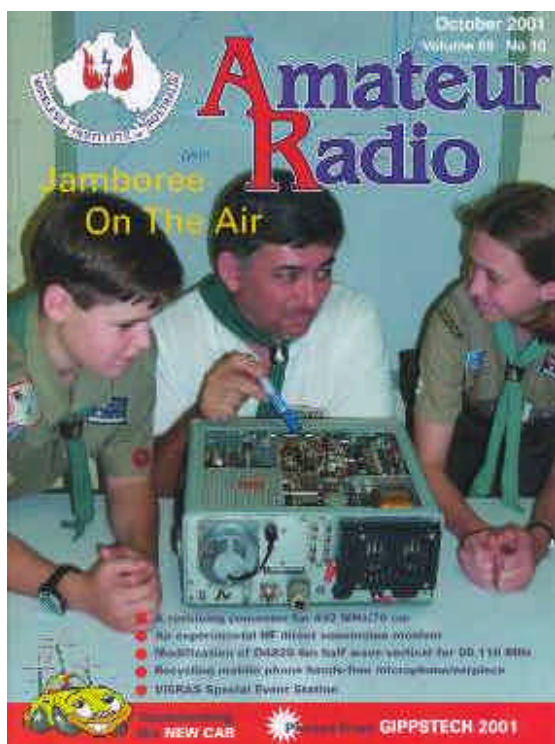

first time in the National JOTA Address. The Address was broadcast throughout Australia on Amateur Radio and was available to download in MP3, Real Audio, and streaming audio via the Scouts Australia website thanks to production and distribution by Graham Kemp VK4BB.

The most exciting contact of the weekend was made by a group of venturers in Sydney when they contacted the International Space Station NA1SS.

A remarkable story came from South Australia where an operator drove for 5 hours from Adelaide to a remote small community in the driest state in Australia to enable Scouts to participate in JOTA for the very first time.

The Queensland Branch HQ JOTA & JOTI base at Baden-Powell Park in Samford went very successfully with over 200 members participating in the camp organised by the Youth Activities Team. The youth members were mainly Joey Scouts, Cub Scouts and Scouts. There were 6 computers on-site loaned from

Business Computing Australia for the weekend and 8 amateur radio operators assisted the running of radio station VK4SAA. Plenty of Australian and overseas contacts were made throughout the weekend.

Several bases in **New South Wales** ran on a district basis with a lot of Groups attending. These seem to be the most popular with the youth members with a lot of activities to keep them busy all weekend. Kit building was popular at all the bases that included it.

The Hawkesbury base at Bowen Mountain had about 200 youth members there with 2 HF sites 1 VHF 1 Packet & Internet. The kit built was the snoop microphone built into a toy plastic gun and a dish reflector. The Venturers went off with the older Scouts on Saturday to find the pieces of a supposed downed satellite using direction-finding receivers. They then decoded information found in the satellite and radioed that info back to the main base.



"Can you hammer that transistor into its place....?"

Southern Region in **Tasmania** had 4 district based stations, operating from Geeveston, Woodbridge, The Lea, and Seven Mile Beach. Northern Region has stations operating from Prospect, Scottsdale, Tamar Bend, Exeter and Alanvale. Northwest Region had stations at Zeehan, Burnie and Ulverstone.



Let me send you some real Aussie pictures.....

Congratulations must go to Clarence District for the large attendance at their district base, and to the West Coast district for obtaining the largest number of contacts made, both overseas and Australian destinations.

On Friday night we in **Western Australia** have what we call the "Midnight Check in" for the die hards who have to be some of the first to call CQ JOTA. This is started by Dennis VK6KHD from our Scout Camp Site at Manjedal in Byford, south of Perth. This year we only had 3 check ins on our 80-mtr freq.

On Saturday the National broadcast went to air on time with 10 VK6's and 17 VK callbacks. The call back stations reported 340 Scouts / Guides listening

to the broadcast.

All amateur radio operators in WA who helped out with JOTA will receive 1 Cloth Badge, 1 Metal Badge and a Certificate for the International year of the Volunteer as well as the Participation Card and JOTA / JOTI Badge.

The Northern Region held a combined Guide and Scout camp at the youth camp site near Darwin River in **Northern Territory**. The overall total would be over 120 persons. The weekend camp theme was communications.

A JOTA station was set up using the call of VK8BP operating HF and VHF. Starting up on Saturday morning HF conditions were very poor but improving later in the day.

This year we introduced a new concept into JOTA; this was IRLP whereby our local repeater 147.00 MHz was linked to the internet thus providing good quality contacts interstate and overseas. This facility was provided by Alan VK8ZAB who maintained a permanent internet connection throughout the weekend.

One minor problem that occurred at the start of operations on HF, we discovered that the rotator would not travel through it's full circle. This was fixed when Phil VK8PT climbed up 72 ft to fix it.

Austria (OE)

participants:	53
stations:	12
internet:	0
countries:	32

Again less participants, writes Walter Nowakowski. Many other scout activities were organized the same weekend. The most loyal



group is the Perchtoldsdorfer with their station at the Teufelsteinhütte.

In Laa an der Thaya Scouts organized a fox hunt; the photo camera was loaded and waiting,....but in vain as we totally forgot it.

Just one station succeeded in contacting the station in Geneva.

German stations were most helpful in getting our Scouts over the microphone shyness, in particular DLOAPJ in Anzing.

Azerbaijan (4K)

participants:	?
stations:	1
internet:	0
countries:	20

The radio club Azi Aslanov, named after a Soviet Union General, participated in the JOTA with 4K1AS, writes Namik Jafarov of the Association of Scouts of Azerbaijan (ASA).

Bolivia (CP)

participants:	608
stations:	27
internet:	?
countries:	12

Juan Carlos Valdivia writes us from Cochacamba: our country consists of 9 departments. On the plains and



CP5AA: watching the birdie.

in the East we find Scouts in very small villages and communities. Agriculture is the main income of these communities, that have a widely dispersed population. In general, these villages have a radio for their communication needs, and that allows the Scouts to take part in JOTA. On the high planes there are mining activities that also have radio installations. From cub Scouts to leaders and parents, they all participated from 27 different stations dispersed over the country, set up at their usual locations or portable from camps.

Canada (VE)

participants:	1141
stations:	23
internet:	6
countries:	28

Lena Wong writes us: Milton, Ontario 1st and 2nd Scout Troops used two radio stations. They reached groups in the USA, Trinidad, Puerto Rico, Jamaica and Slovenia. Between contacts they also managed to enjoy some outdoor activities.

At Camp Discovery, the 1st Borden Scout Group from Ontario found that the JOTA frequencies were extremely busy. Everyone enjoyed JOTA and was very enthusiastic about the use of a radio. One leader has expressed interest in becoming a radio amateur. Contacts were

made with several Ontario and USA stations.

The 8th Sackville Scout Troop took part at the Halifax Amateur Radio Club facility in Halifax, Nova Scotia. The Scouts enjoyed talking to their American counterparts and were surprised to discover many differences in Canadian and US Scouting. Initial shyness was quickly overcome once they



Smile! We've got another one on the map....!

started talking to other youth.

Staying in Ontario, the 1st Bolton Scout Group experienced their first JOTA. With the help of the Peel Region Amateur Radio Club they operated two stations, one of which was a receiver only. Scouts Canada leaders attending a training course nearby visited the station to observe the activities. This group enjoyed their experience and are committed to making JOTA an annual event.

Meanwhile, in British Columbia, the 10th White Rock Pack made contacts with several US stations. While they were all strong to begin

with they faded quickly. Conversations were heard from stations in the Yukon, Japan and Nevada but it was not possible to contact these.

We received three reports from Grande Prairie, Alberta, so JOTA made a mark in this community. The event was organized and promoted by Keith Harper who is both a Radio Amateur and a Scouter. Contacts were made on the VHF/UHF linking system with groups across continental North America. They reached two "special events" stations - one at a lighthouse in Florida and one on the Isle of Manikiki south of Hawaii. First Grande Prairie Scouts were split into two groups using a mobile car radio and a regular radio set. One adult from BC found the fact that girls are now "allowed" in Scouting was worth a lengthy conversation.

Another "first timer" group, 75th Old Mill Scout Troop from Ontario, had a very successful weekend with the help of an avid radio amateur who went out of his way to prepare the group prior to the event and then ran a great station during JOTA. Contacts were made in the USA, the UK and Switzerland. The two most memorable were with a group in Sherwood Forest (home of Robin Hood) and the World Bureau's station HB9S. One of the Scouts was able to practice his French in talking to Yves.

At Langley Park Scout Camp, also in Ontario, the station was set up at the annual Peterborough District Camporee and attracted a lot of attention. The most memorable conversation was with Patty in Richardson, TX who had visited Peterborough on a houseboat vacation trip on the Trent Severn Waterway. Patty shared a lot of her knowledge and experience with the youth and everyone enjoyed the connection.



"....it's just the two of us here...."

Kelowna, British Columbia is the home of 1st Glenmore and 1st Lakeview Cubs and Scouts. One of the youth participants was a licensed radio amateur and was able to get some e-mail addresses for further friendly communications. The weather at camp was

cool with snow on the ground. Contacts were made all over North America and a South African station was heard during the best propagation. Contact was not made because of a long line-up. Interesting stations were a troop camped at a missile base in California and a floating radio station in the

Columbia River in Oregon. The youth thoroughly enjoyed the experience and a number have expressed interest in getting their own licenses.

Finally, on Prince Edward Island, O'Leary Scouts made contacts with stations in several European countries, Australia and North America. They were the second group to report a contact with HB9S in Geneva where they spoke to Mike.

Chile (CE)

participants:	7800
stations:	80
internet:	0
countries:	12

The radio staff of the Chilean Scouts and Guides Association consisted of 6 licensed radio Scouts and an invited radio amateur, says Isabel Carreño.

The executive national Director Julio Robles inaugurated the JOTA event for Chile on the Saturday. Two Scout groups, the "Sagrada Familia Chilena" and the "Santa Clara", were present at the ceremony that took place in the Baden-Powell room of the National HQ where CE3JAM was located.

In distant regions of the country we counted on the support of coordinators for the local activities. These were CA2WTX in the city of La Serena in the North of Chile. And in the South CE5UBB, the station of the Bio-Bio University in Concepción. Both stations helped with retransmissions and were the point of contact when needed as the official stations in the North and the South.

Amongst all the JOTA activities, the one that motivated the youngsters the most was sending a peace message to other guides and Scouts around the world. This was done with utmost responsibility and enthusiasm.

A large poster for the JOTA / JOTI was produced and sent to all participating groups to promote the event. Printed on A2 format, it could be divided in two using a perforation line. So groups had a choice to display the JOTA part, the JOTI part or both. Well done.



Hé, listen !!

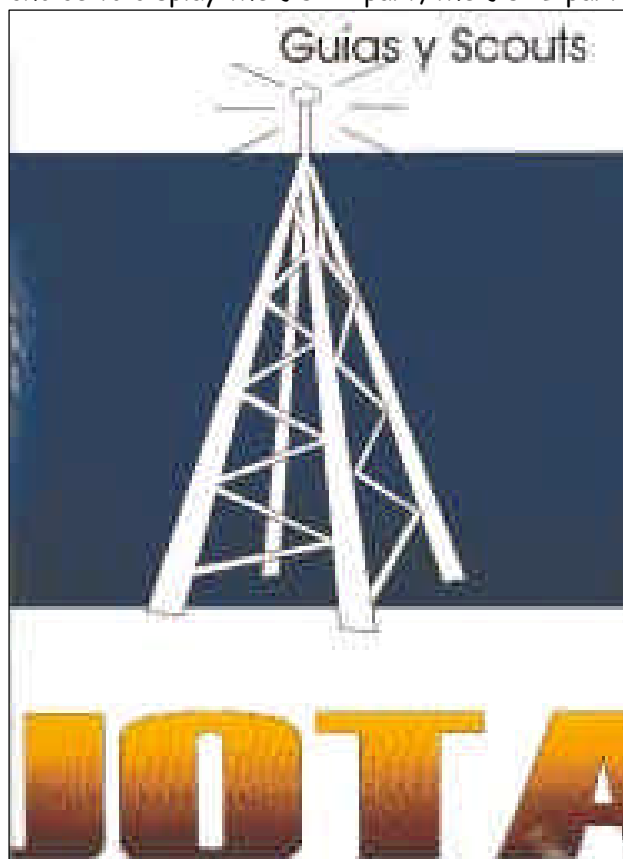

"...we grow palm trees and beam trees...."

Cyprus (5B4)

participants:	800
stations:	16
internet:	0
countries:	17

Seventeen JOTA Stations planned to operate this year but only sixteen were in action.

Five were operating on VHF only.

Radio amateurism is not flourishing in Cyprus so we decided to promote and train our Scouts in the amateur radio hobby. We will have trained and licensed scouters to continue the JOTA, writes Erricos Lanitis.



Hello from Cyprus !!

Denmark (OZ)

participants:	?
stations:	43
internet:	23
countries:	32

As usual, claims Brian Lodahl, our friends OY6SNP from Færøerne participated, although they had it a bit rough with the weather in the north Atlantic area. More than once, the antennas had to be taken down to be repaired and

then put back up due to strong winds (abt. 15-20 m/s). OX3NUK and OX3JOT were also QRV from Nuuk and Kobberfjorden, Greenland.

This year, Mr. Niels Krogh HANSEN OZ1IKW, chairman of the Danish Amateur Radio League, gave the opening speech. The topic of the speech was communication and the common interests in communication between Scouts and radio amateurs. Also, Niels told the Scouts about the new approach to obtaining a ham license, by regulations from the Danish telecommunication authorities.

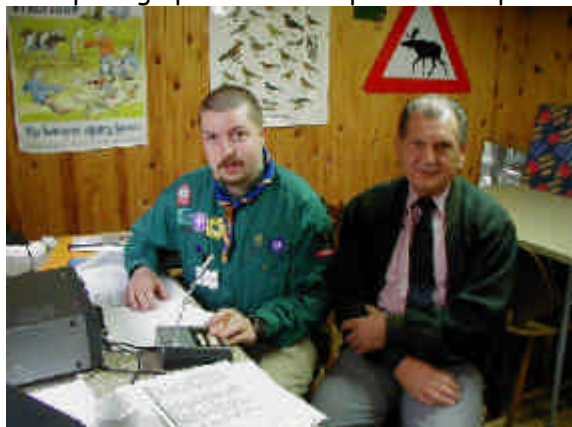

Brian Lodahl and Niels Hansen at the Danish JOTA opening.

During the past few years and in the upcoming year, several anniversary stations emerge. OZ3FRB had 10-year anniversary this year, OZ1MD will have their 20th in 2002 and OZ9EVA had their 25th in 2000. There are several others, and we congratulate them all.

Sunday at about 3 AM (can't remember the exact time), I was fooling around on the bands. I really needed to go to bed, but I couldn't just leave the radio when I could still hear stations QRV. Suddenly,

I heard the very faint voice of GB4YOU, Liz, whom I had met on the radio Scouting seminar in Rome last year. She was having a QSO with Mark (I believe it was) at HB9S. The conditions were very poor, and I just wanted to bring her my best regards, so I broke and had HB9S relay my greetings to Liz. Thanks to both HB9S and GB4YOU for this exiting sked and I hope to see and hear you soon again.

I heard the very faint voice of GB4YOU, Liz, whom I had met on the radio Scouting seminar in Rome last year. She was having a QSO with Mark (I believe it was) at HB9S. The conditions were very poor, and I just wanted to bring her my best regards, so I broke and had HB9S relay my greetings to Liz. Thanks to both HB9S and GB4YOU for this exiting sked and I hope to see and hear you soon again.

Germany (DL)

participants:	345
stations:	11
internet:	10
countries:	20

The good Cupertino between the German radio-association DARC (= Deutscher Amateur Radio Club) and the German Scout-associations of the RdP (Ring deutscher Pfadfinderverbände) went on.

The DARC-manager Mr. Häfner promised to sponsor this year again envelopes and stamps to send a 16-side JOTA/JOTI-booklet to all Scout groups in Germany. The paper informed participants how to organise a JOTA/JOTI-weekend and gave information about national activities.

The 8th national meeting of the German-Scout-Net (GSN), held in May, 18th - 20th in the DPSG-Scout-house



„Lindersberg“ was an international weekend for the first time; Walter, OE1WN, National JOTA Organizer of Austria and his assistant Ernst, OE1EOA, took part the whole weekend.

The online-registration-form was very well taken over by the Scout-groups.

During the JOTA-weekend the DL-sked on Saturday afternoon was a big party with a lot of German radio-Scout-stations. Klaus, the NJO of DPSG, was the guest of the DARC and organized the meeting



Lindersberg im Mai: na Leute.... guck mal alle hierher.....

from the DARC-HQ-station with a big signal, well heard in the whole country. Sometimes they switched over to DFOCP, the VCP-HQ-station, to send out the DL-sked-Game; a puzzle game in several parts, where a telephone-number was to find out.

The German Communication-Game,

connecting JOTA and JOTI, was a great success! This year a 15 line long old song was given in separate lines to all German participants. The aim of this game was, to find out all lines by contacting other Scout-groups and exchanging all known information. Some Scouts were very creative, created some new lines of the song and gave them into public, too.

The use of the Packet-Radio DL-Convers-round was very popular for the Scouts. Nearly the whole weekend - including the nighttime - the meeting-channel was well filled. Some groups looked for short-wave-sked-partners; others asked for new lines of the communication-game or answers to the DL-Sked-game, ... or wanted to talk.

„Stamm Friedrich Schiller“ from Gerlingen built up a computer-network and a radio-station (DL0SFS). A fast T-DSL-modem and a solid system were the warranty for no breakdowns during the weekend and good contacts to Australia and the United States.

„Stamm Weisse Rose“ of the VCP-Barmstedt get good support from the amateur radio-group of their town. They had the chance to listen to a radio-contact to ISS from outer space.

In Dortmund a big weekend-party was organized. 12 Scout-groups with at all about 60 participants from Dortmund, Grevenbroich, Duesseldorf, Hannover, Vechta and Aachen shared their place on a campsite in tents. The cup-Scouts from VCP-Hannover returned home very enthusiastic about it all. Now they know, how to explain their names into a microphone.....



The Greek JOTA is an outdoor activity.

Greece (SV)

participants:	352
stations:	14
internet:	50
countries:	18

No further details in the report.

Iceland (TF)

participants:	85
stations:	2
internet:	2
countries:	22

Icelandic Radio Scouts were running JOTA from 2 sites this year, TF1JAM from Ulfljotsvatn and TF3JAM from Reykjavik. One Scout troop from Reykjavik visited TF1JAM (a 50-km drive) on Saturday and another Scout troop was camping at Ulfljotsvatn this weekend and took

part in JOTA as well.

During the weekend scouts could do lot of stuff in many workshops available, for example make candles, go swimming, melting of metal, mountain-walking and many other things.

During JOTA our most exciting contacts were with HB9S (Mike had trouble with all the other guys waiting to make qso with him), Greenland and Zimbabwe. This year we managed to talk to lot of Scout stations, a total of 71 qso with JOTA stations.

Once when we were in heavy pile up, one JOTA station from Norway made it through to us at TF1JAM. After usual start of qso the operator confused us a lot when he began to talk Icelandic to us! That was quite funny.

Icelandic scouts are discovering that JOTA is lot of fun that is worth taking part in. In July 2002 we will have national jamboree in Iceland where Radio Scouts will be very active writes Konrad Thorisson.

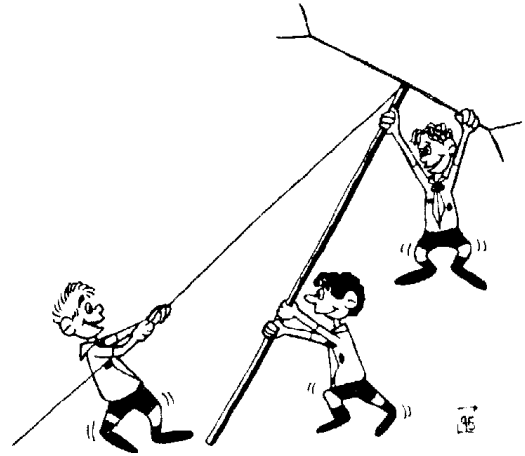

Indonesia (YB)

participants:	1020
stations:	68
internet:	115
countries:	8

The Indonesian Scout Movement successfully organised the 44th JOTA event with the full support of ORARI, the Indonesian amateur radio organisation, reports James Darmawan.

Prior to the starting moment at 1700 local time (1000 UTC) a nation-wide roll call was made by two stations to provide better coverage for the whole nation. Another rollcall was also held prior to closing. The eastern part of Indonesia was covered by YB3ZKZ, located in Surabaya, and the western part of Indonesia was handled by YB4ZKZ a special event club station established for a national rover and ranger moot at a camping ground in Lampung province.

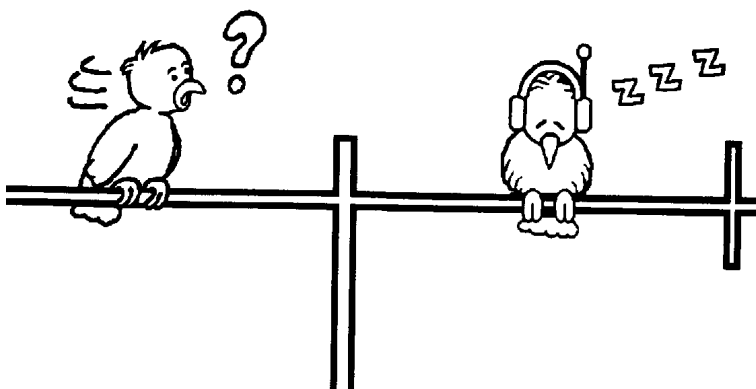

Each station that assisted the national, provincial and district scout headquarters used specially allocated JOTA callsigns, e.g.. YB0S for the National Headquarters Club station, YB0ZS for the Jakarta provincial HQ, YCOZSA - ZSZ for districts in the 0 call area. Many more Indonesian amateur radio club stations were also on air as JOTA stations for individual troops.

YB0S managed to contact 37 Indonesian stations. This was achieved in between the national JOTA monitoring activities. Our YB0S operator, Andreas (YB0AZ), managed a QSO with Yves operating from HB9S in Geneva.

On this occasion, National headquarters is issuing a special award (KaKwarnas Award) to Indonesian JOTA stations that managed to QSO with HB9S, YB0S and 5 other JOTA provincial headquarters stations. Stations eligible for the award must prove their contacts by submitting notarised logsheets.

International Space (ISS)

participants:	1
stations:	1
internet:	0
countries:	many

JOTA has a new dimension. Literally. It appeared that JOTA this year was also supported by a lonely station far out in space. To be exact, International Space Station crew commander Frank Culbertson, on board the ISS had some skeds during a few orbits both Saturday and Sunday with his station NA1SS. He himself

has also been a Scout in the USA some years ago. Frank took up the NA1SS microphone and worked a string of JOTA participants in the US and abroad, reported the ARRL web site and NASA sources.

"Frank Culbertson left a global trail of excited Scouts this weekend as he made rapid contacts during Jamboree On The Air," said Gene Chapline, K5YFL. NASA announced that Culbertson was going to try to make time available to put some JOTA contacts in the NA1SS log and had even brought along his Scout T-shirt in anticipation.

Among the happy customers was Al Lark, KD4SFF, who reports that Jonathan, a member of Troop 555, spoke to Culbertson during a Saturday pass. "We were set up in my backyard, here in Greenville, South Carolina. Frank was also excited to speak to a Scout from his home state of South Carolina."

On a Sunday pass over the US, Culbertson also logged contacts with K2BSA, the official Boy Scouts of



Commander Culbertson in JOTA: "it's really amazing up here...."

America station near Dallas, as well as with other stations in Texas, New Mexico, the Midwest and the Northeast.

In Louisiana, Cedric Walker, K5CFW, said his Scout group talked to Culbertson during the same Sunday pass. "Because of the advance notice, we were able to put together a rig to work the space station on its direct pass over New Orleans. We had 16 boys from Troop 48 in New Orleans and the crystal-clear contact with Commander Culbertson worked perfectly and was an unforgettable thrill for every one of them."

From Australia, Tony Hutchison, VK5ZAI, in Paringa said his Scouting group managed a contact with Culbertson. "Frank did a fine job over Australia on the scheduled pass. I took a portable station down to the Riverland Scout Hall, and we had one of the senior girls ask a question, which he answered."

While over Europe, Culbertson whipped through another series of JOTA contacts.



Trudi Arnold, an Australian venture Scout, writes: On the 20th October 2001 when most people are vast asleep, a lone group of Australian Venturers, 3rd Rose Bay Judean Scout Group, participated in JOTA with VK2BV; but this time an extremely rare but exciting conversation with the commander of the International Space Station, Frank Culbertson, took place while the space station flew over Australia for around 10 minutes.

We called "NA1SS, this is VK2BV calling out for JOTA, this is VK2BV is anyone out there?". After a few unsuccessful tries we were finally able to personally address the commander himself, and for the next 10 minutes had a very exciting conversation. The rendezvous was very rare as the astronauts

seldom have time to speak to amateur radio operators. The thought of talking to astronauts high up in space seemed like something out of a fairytale

The first question we asked him was in relation to his star signs. We found out that the commander was a Taurus. How interesting!

During our conversation we obtained the following information. Frank Culbertson enjoys using his email, listening to tapes and watching movies in his free time, and of course admiring the wonderful view that lies out the window of the space station. Frank responded to the question of "how's the view?" saying that "It's really amazing up here!" We also found that the space Station follows Greenwich Mean Time and travels at mind boggling speeds of 8km a second, which explains why we were only able to speak to the commander for 10 minutes while the Station raced over "our land down under". At the time of the conversation, the station was at an altitude of 310km.

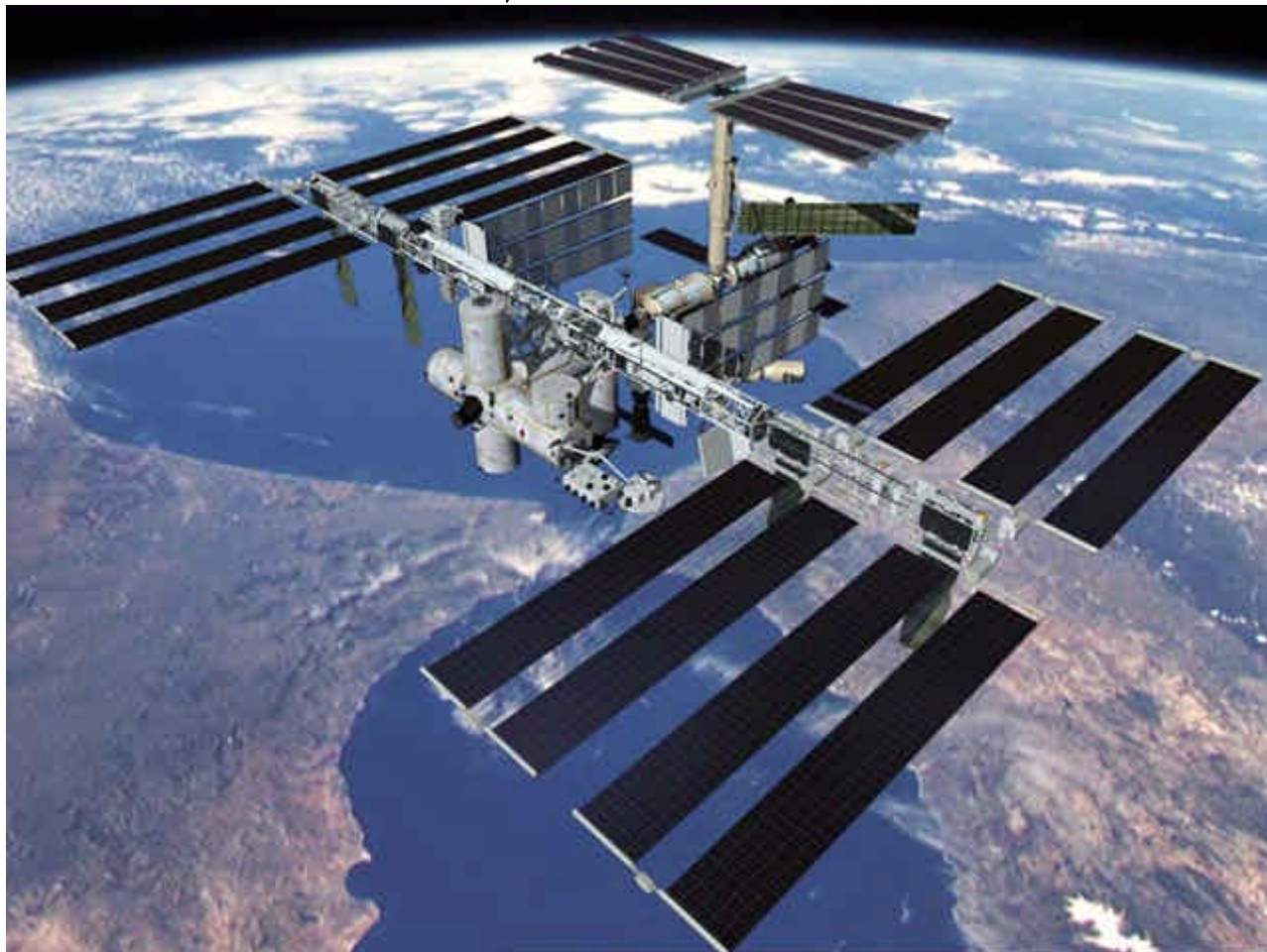

"CQ Jamboree, CQ Jamboree, this is November Alfa One Scout Station, this is NA1SS calling CQ Jamboree. Is anyone out there?"

We found out the commander's routines consisted of getting up at 6am and going to bed at 10pm in between performing laboratory experiments on the effects of "Zero G" on human beings. As part of the expedition, Frank is also participating in his first spacewalk. In response to the question we asked him about homesickness, Mr Culbertson said that "I do miss my friends and mostly my kids and wife but keep myself busy by writing emails, listening to tapes and watching movies."

We made the comment that we were all very jealous of him having the opportunity to live in space. In response to this he said, "we wish there were more people up here!" He was very impressed with the questions that we had put together which made the conversation both interesting and entertaining for both camps.

It was pretty amazing to think that we were able to look up to the heavens and say that we spoke to astronauts. The reception between both radios was (contrary to our beliefs) very good and was crystal clear, with the response time just as quick as if we were talking to someone on a telephone. It was

a wonderful experience and we consider ourselves very lucky to have been able to witness and participate in such an amazing event!



The radio operator of the Scout group, Raffy Shamma, VK2RF, has the technical details for us:

The Radio used was a Yaesu FT-480 with a 2-meter band vertical on the roof.

We tuned to the ISS frequencies about half an hour before the predicted pass and waited for any activity. I responded and was amazed and gratified at the excellent audio quality. The angle of the pass was 80 degrees off the horizon at 310 km, which was a perfect trajectory from our perspective.

When the signal started degrading, Anna very excitedly said the final thankyou and goodbyes, and after a short response thanking us for the interesting questions, he was gone. At 28,000 kph it had been an amazingly busy ten minutes.

Then there was a breathless pause as all the participants realized they had just spoken to the commander of the International Space Station in orbit directly, one to one, without any complex procedures or regulation.

Then the elated and exulted prancing and conversation began. Everyone, including me, was on a high for a week! This was one of the rarest and special experiences of a lifetime!

Ireland (EI)

participants:	35
stations:	?
internet:	0
countries:	17

JOTA 2001 was a major success in Ireland, says Patrick Geoghegan. The number of stations taking part and the number of Scouts involved is growing steadily year by year. Amateur radio operators are very happy with the co-operation and assistance they are getting from individual Scout units, helping to make the event more enjoyable for all participants.

The Scout Activity Centre at Mount Melleray, EI5MRC, had a very full programme of events and activities planned for the weekend, the sudden death of well known and much loved Scout Leader in Waterford on the Thursday meant that Scout participation was cancelled. The Station was activated for some hours on the Saturday by local Radio Amateurs.

The 132nd Dublin (Bayside) held JOTA with EI4BST/J in the Unit's Scout Den on the edge of Dublin Bay. We had two HF stations, one for SSB, the other for PSK. There were also two 2M stations, one for voice (FM) and the other for packet. There was great interest in the passes of the International Space Station (ISS). There was great excitement when expedition 3 Commander, Frank L.Culbertson Jr, KD5OPQ was heard calling CQ and working stations using the callsign NA1SS on 3 of the passes over the weekend. Signals from the ISS were so strong he could even be heard on handhelds. While we had no success in having a voice QSO with NA1SS, we did transmit packet messages via the ISS digipeater on 2 passes which were received in Holland.



Italy (I)

participants:	270
stations:	7
internet:	3
countries:	23

In the area of Cassino, the JOTA event is well known and several groups have taken part in it for many years. The JOTA has often been utilised by the Groups as an occasion to start activities, or as an occasion to let parents participate, or

visitors, citizens, students and also radio amateurs; all that helps to make them aware of the international dimension of Scouting. Scout exhibitions, philatelists exhibitions, games and many other activities were presented to the same aim, writes Sandro Naspì.

The place chosen for the national station IROBP was really something special: the Benedictine "Abbey of Montecassino", the famous abbey halfway between Rome and Naples, which was destroyed during the Second World War and then rebuilt. The Scouts asked and obtained the permission of the Town Council who offered the transport and publicity for the event.

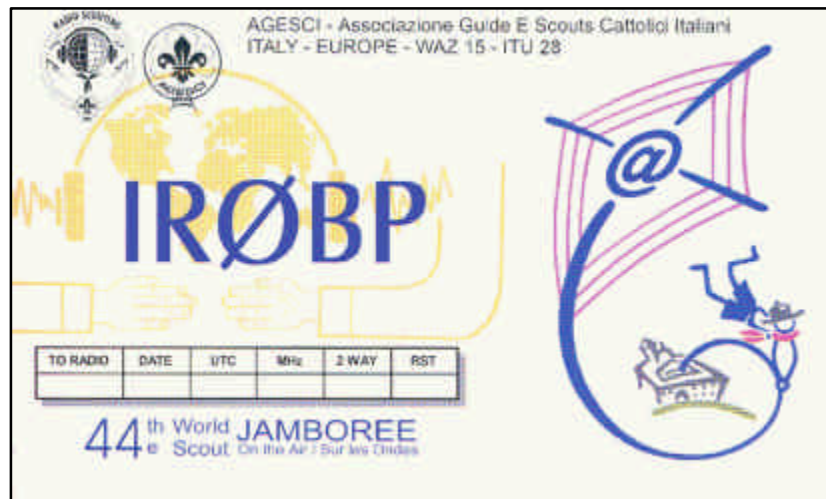

On Saturday morning, when the larger part of Scouts and girl-guides couldn't participate because of school, about 200 students from the different schools, accompanied by their teachers, were invited; they had the chance to visit the different stations. The Scouts and Guides that were there, were divided into six groups, each of them made up of 15 people (attention to don't divide the patrols). Each group moved from a stationing to another one every 45 minutes. The groups were identified by a different colour and by a letter of the phonetic alphabet (Alfa, Bravo, Charlie, ...) described on a ticket given to each guide and Scout.

On Sunday, at midday, a violent downpour caused the interruption of the activities. Even the transmission were stopped because of an electric blackout, except the ones fed with a battery; these ones



IROBP: power from the sun.

attracted the attention and the curiosity of all people. The speciality of this station lies in the fact that it was fed with solar energy produced there from a truck, parked nearby, together with a model of an Aeolian generator. One of the themes, which we invited the Scouts and guides to reflect upon, was the use of the electrical energy for the different equipment necessary to the JOTA; in particular upon the use and the characteristics of alternative energy sources. For this purpose, we solicited help and advice from the "Erga Spa" company. They put to our disposal a

"Photovoltaic truck" which fed the radio station, a model of a wind generator, a little solar panel by which a bulb was directly fed, an illustrative board of the different sources of alternative energies and two specialized technicians who showed the working of the machines; they also answered the numerous questions of the boys. The "Erga Spa" company sent a TV troupe that made a special of the event, which was transmitted on a WEB-TV.

The groups of guides and Scouts that arrived at the radio station, listened to a theoretical explanation (some information about the Radio Scout Sector, with history and working of the JOTA and the first elements about radio techniques), whilst other groups listened to the explanations of the radio amateurs who were operating and participating in contacts.

A communication game with letters and numbers, communicated with flag signalling and Morse, was organized too. From a rock in front of the camp, Vincenzo Moreschini (IZØDRB), using 43 MHz radio and nautical flags and a group of rover Scouts chose the best expert in Morse transmission by communicating with other Scouts that where on a hill 2 km away.



The Scout Philatelic exhibition, in the rooms inside the Benedictine Abbey, was by exception open to us. The aim was to make people aware of Scout stamps, but also to let our boys and girls understand how important Scouting is all over the world. In so doing we tried to create a connection with the principal themes of the JOTA. On Sunday morning a special mail postmark of the Italian Mail was given out, which will commemorate this manifestation.

Japan (JA)

participants:	573
stations:	71
internet:	7
countries:	15

Toichiro Nishiyama reports: before the JOTA, the Scout Association of Japan circulated the information to

Scouts and leaders through local Scout Councils and Scouting magazines.

The Nippon Boy Scout Amateur Radio Club (JA1YSS) operated their station from the National Headquarters of the Scout Association of Japan.

It was reported this year again that many portable stations were operated during the JOTA such as in mountains, at banks of rivers, at Scout halls, at outdoor activity centres, etc.

Scouts reported that they could learn the "Scout Law and Promise" of other countries through the JOTA communications.



"Woow, look at that !

Luxemburg (LX)

participants:	370
stations:	16
internet:	2
countries:	27

This year 18 luxemburgish JOTA stations took part, writes Claude Engel. The national JOTA-team, composed of members of the two Scout federations, the coordinator of the national amateur radio federation and two other members, organized a meeting in July to prepare the Scout leaders and the radio operators for

this event. During this meeting, the call signs were assigned to the JOTA-stations and lots of theoretical hints and information were given to the participants. A JOTA-handbook (already our 5th edition) was also distributed to the Scout leaders to provide them with the required technical background. Three weeks before the JOTA weekend, we organized a practical training evening in different communication techniques and kit building for the Scout leaders.

The event itself was officially opened with a speech by the two international commissioners of our two federations. A national JOTA game, whose aim was to encourage all luxemburgish JOTA stations to contact each other, and which consisted of drawing a life circle from the lowest to the highest life form, generated a lot of interest.



Malaysia (9M2)

participants:	3200
stations:	14
internet:	4
countries:	10

Here in Malaysia, Penang has always been the most active state to take part in JOTA, says Tan Sow Sung. About 650 scouts and guides from all over the Penang Island took part at the Penang State JOTA-Joti in Camp Coronation. Over in Bukit Mertajam on the mainland, about 800 scouts and guides from the northern

states of Malaysia took part in the Bukit Mertajam District JOTA-Joti in Kim Sen School. Using the official call sign of Mr. Leong Kok Hin (9M2HK) and assisted by Mr. Richard Lye (9M2LR), both of them and their friends had a hard time making contacts with other stations due to the not so good radio conditions. They managed to make contact with scout stations from India, Australia and New Zealand.

Besides trying out the JOTA-Joti stations, the participants also had a great time taking part in all types of activities including telematch and games to obtain their JOTA-Joti Challenge Badge. At night, a big gathering was held in the school hall where the scouts and guides presented all types of sketches and dances to win the best item trophy. Mr. Khoo Heng San, the Penang State Scout Commissioner, was present to open the 44th Bukit Mertajam District JOTA. In Kota Kinabalu, the Sabah State JOTA was held at B.P. House (9M6BPC) and official bases at major towns around the state. Overall, this year saw a big reduction in participants because of confusion about a new holiday ruling from the Education Ministry. Hopefully things will be back to normal next year.

Mexico (XE)

participants:	700
stations:	54
internet:	0
countries:	3

Xochitl Prado Serrano writes: The official station of JOTA was in República de Irlanda Kindergarten. The scout



"hola, aqui esta Mexico ! Me lamo Isabel. ¿ Y tu ?"

group 76 "Amanecer" was in the station.

We had 50 contacts, three of them with other countrys: Peru, Venezuela and Dominican Republic. We enjoyed this activity; more gazelles and cubs discovered other forms of comunication and they have new friends now in others cites. Scouts played songs and exchanged anecdotes. Rovers talked about diferents topics in scouting.

Adjacent activities we did: a guard book with contacts, games and technical cards; pines, posters, pens and patches.

Namibia (V51)

participants:	?
stations:	1
internet:	1
countries:	27

Jim Kastelic writes us: 1st Tsumeb Scout Groups participated in the 44th annual World Scout "Jamboree on the Air" during the weekend. Using the callsign V5TSB, they were sending Scouting greetings over the airwaves from the radio shack of 71-year-old operator Robbie Robinson (V51ER). "Uncle Robbie" helped

the Scouts contact 68 amateur radio stations in 27 countries. The Scouts exchanged Scouting notes with fellow Scouts around the world. Working two at a time in three-hour shifts, they recorded

every contact in a logbook and pinpointed each station on a large world map. This year the Troop had a special guest -- Thomas Amutenya, a

Group Scouter from 1st Valombola in the far north of the country, who was invited to take part in the activity and to observe how JOTA works.

This was done in the hope that the annual event can be expanded to Troops in the northern regions, where most of Namibia's Scouts live.

The highlight of the weekend was a contact with the World Scout Bureau (HB9S) in Geneva, Switzerland, on Saturday morning, Oct. 20.

During this exchange, 1st Tsumeb's Group Scoutmaster, who received his full amateur radio license only two days before, had the chance to chat with world JOTA Organizer Richard Middelkoop.

The Scouts camped out in the cool, tree-shrouded surroundings of the Caravan Park on the edge of town. From time to time they went

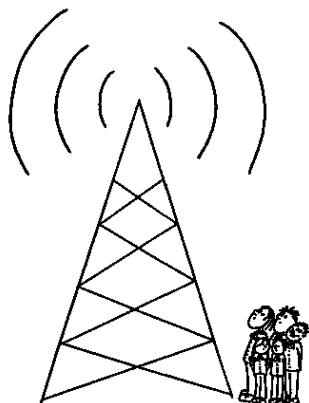

swimming at the public pool. Other activities included semaphore, baking chicken in reflector ovens, open-fire cooking, making camp gadgets, and visiting the nearby Tsumeb Cultural Village. On Saturday night everybody sang along at the high-spirited campfire. At the end of the jamboree, the tired but happy Scouts received a special uniform badge to commemorate the first JOTA of the new millennium.

Netherlands (PA)

participants:	24843
stations:	254
internet:	56
countries:	42

The JOTA started this year with a surprise for

Gerard Blonk, PA3EIE. He received the Silver Award of Scouting Nederland in the opening broadcast. Gerard has been a driving force in many (Radio) Scouting activities, like co-founding the Dutch "Radio Interested Scouts", electronic kitbuilding at many camps like the World Jamboree in 1995, and organising the JOTA on national level in the Netherlands.

The Agger Martini troop, PI4AMG/J, made a contact with a Boeing 727-200 on Sunday morning.

The pilot was a radio amateur and during a national flight in Brazil, above the Amazon, he was QRV! Hertog van Gelre troop, PBOANL/J, had a big ear. One could listen to the thoughts of other people. A large parabolic antenna, a microphone and a headset, and you could hear the whisper at the other end of the field.

Van Naeltwijckgroep, PA3GVQ/J made contact with an American amateur in Kuwait. The amateur had been a Scout himself, and it ended up in a long QSO.

Sint Joris troop and Secr. Moonen troop, PA1PLT/J hosted an English Scout troop from the close-by military base in Rheindahlen (Germany). The Scouts were impressed.

The Sint Laurentius troop, PA3EQC/J, had their JOTA station located at the famous cheese market of Alkmaar. Their longest QSO was a contact with Austria, which lasted 1,5 hours. One of the Austrians will visit the group in December.

The Van Daal troop, PA1FJ/J, organised a foxhunt with their beavers (!). It was a brilliant experience to see how the beavers did it.

The Princes Irene-troop, PA3GJJ/J, worked this year for



"...ik weet zeker dat dit zijn laatste positie was!"



There are towers and there are towers...



the first time in PSK31 mode. Several Scout station were active in PSK-mode, for example K3BSA (Boy Scouts of America). It is a pity we could not work this station, but we worked several other JOTA-PSK stations in Europe.

The Woudlopers, PA2ION/J, hosted again Canadian Scouts. It was a very successful weekend, and the language barrier did not seem to exist for some of the Scouts.

The well-known JOTA logbook program was improved. QSO's are now visualised on a map with a line between both stations. The program proved to be very popular, 64% of the Dutch JOTA stations used it. The Dutch JOTA organisation published their 4th annual JOTA CD-ROM. The CD-ROM contains reports of 47 JOTA and JOTI stations in the Netherlands; most contributions include photos, QSL-card and newspaper cuttings. A nice way of preserving good memories concludes Jan Kluiver.

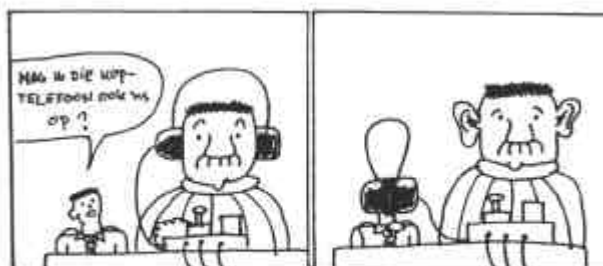

"May I use the headphones please?"

New Zealand (ZL)

participants:	?
stations:	?
internet:	?
countries:	?

As usual, Scouts and Guides in widely scattered parts of

New Zealand took part in this annual event with the co-operation of their local radio amateurs, writes Jim Parnell. Numbers were down because the event clashed

with Labour Weekend which it does from time to time. Excellent contacts were made both within New Zealand and overseas although conditions were not very good. A special JOTA station was set up at Tatum Park for the Upper Hutt District Scouts. At a camp at Aramoana near Dunedin, a search and rescue exercise with Civil Defence radios was carried out with great success in conjunction with the JOTA station.

The 16th New Zealand Jamboree ran for 8 days over the 2001/2002 New Year period, and was attended by some 3400 scouts and 1000 leaders. Members of the Hamilton Amateur Radio Club operated an amateur radio station, ZL6JAM, during the jamboree activity hours (9am to 5 PM) and also for one evening.

On HF, only about 100 contacts were made, but this was due to poor propagation during daylight hours and limited power (100 watts into a trapped dipole). All countries are literally DX for New Zealand amateurs! Nevertheless, contacts into Europe, Asia, the USA and Australia were made. Demonstrations were made of packet radio, APRS, and SSTV.

Fox hunting on 80 meters was another activity provided at the amateur radio base and it was very popular. Over 1000 scouts visited the station and a similar number foxhunted. Although not part of the amateur provided radio facilities, the jamboree operated its own FM broadcast radio - 100.5 FM. It was manned by about a dozen or so Venturer Scouts and operated for the duration of the jamboree. Recorded programme material was stored on a hard drive in MP3 format on the station's computer.



Nigeria (5N4)

participants:	130
stations:	7
internet:	0
countries:	?

Rev. O.S. Adetunji writes us: the JOTA event was held at the Lagos State Scout Council Vocational Training Centre Ogudu-Ojota in Lagos, with Cubs, Scouts, Ventures and Explorers. The Amateur

Radio Society of Nigeria provided radio communication gadgets, which were mounted on Friday night. The station manager/operator was Ohman Francis Ikeh, ably assisted by Ohman Christian A. Ikeh.

The JOTA 2001 was opened by the Chief Commissioner of the Scout Association of Nigeria, Chief Efiom E. Okon. In his speech, he charged all Scouts in Nigeria to go forth from the jamboree with a new responsibility upon them to be apostles of peace and good will in the country. Chief Okon wished them happy 44th JOTA.

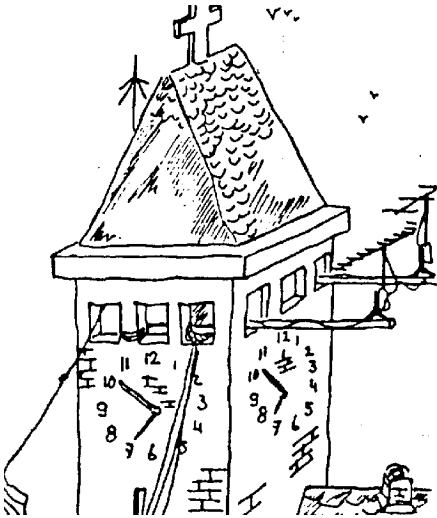

Cubs, Scouts, Ventures and Explorers took turns in communicating with scouts in Nigeria and exchanged yawns, brief history and addresses between stations. Stations were located in Edo, Kano, Kaduna, Kwara, Akwa-Ibom and Abuja.

A cultural display was performed by the Scouts from Bariga Local Association in Lagos, while some part of their display and songs was on the air for other JOTA participants nation-wide.

Cubs and Scouts were provided with the opportunity of passing their efficiency tests with the help of experienced and qualified Scouters that attended the JOTA.

A campfire was held on Saturday. Despite the heavy downpour, the boys and girls in all the four Scout sections, together with their Scouters defied the heavy rain to mark the event. Parts of the camp yawns were on the air for other JOTA stations.

Other dignitaries that graced the occasion include Chief Efiom E. Okon (Chief Commissioner), Elder Aki Eyo Aki (Asst. Chief Commissioner, International), Pa A.A. Lasaki (National Training Commissioner), Mr. Z.A. Afolami, Mr. T.A Balogun (Secretary Lagos State Scout Council) and Mr. T.T. Fatogun (Lagos state Training Commissioner).

Norway (LA)

participants:	521
stations:	25
internet:	9
countries:	20

This year's JOTA/JOTI was held in a traditional fashion, with Nordic co-operation, and a joint Nordic puzzle, Finland being in charge of the latter.

Many groups held their event in cottages or other Scouting facilities. Some slept indoors, while others chose to sleep outside, depending on weather conditions.

The Norwegian headquarters were situated at Nedre Romerrike. Working alongside me this year I had LA4PGA Trond, LA1AKA Torstein, LB7FE Iren, and LC6OAT Ragnar. Vice President Iacob Iuell Nordby, who transmitted from LA2BBA, using the callsign LA1SS, conducted the opening. After the opening, we surrendered the air to Sweden, and performed a check-in of all the Norwegian stations. Some stations had something on their mind, and we received a lot of information. After the check-in, LA1JAM functioned as a regular JOTA station for the remainder of that day.

Over the years we have developed deep traditions, and this year LA2QP celebrated its 30-year anniversary with its own signature during the JOTA, says Dag Anders Kjøenes.

In the Nordic region, we have a tradition to exchange puzzles, by airing bits and pieces of the puzzles to other JOTA stations, and later sharing these pieces with each other.



Now that I have this microphone, what shall I do with it....?

Oman (A4)

participants:	160
stations:	1
internet:	5
countries:	46

The National Organization for Scouts & Guides in the Sultanate of OMAN, participated actively in the 44th JOTA. At the dawn of Saturday (00.01 GMT) the 1st CQ call was transmitted to hunt scout voices at the other end of the world, reports Dawood.

Due to the prior preparations by the organizing Committee, practical and theory exercises were given to all participants, so they were able to sit behind the microphone and have QSOs with their counterparts around the world. Scouts are allowed to transmit under the supervision of licensed operators.

According to the timetable which made all contingents had a chance to participate for 48 hrs continuously, and also they operated for the



Omani Scouts in action.

first time digital radio transmission; photos and written messages were exchanged. As usual the special A47JOTA call sign been assigned. The event was covered by local TV and Radio as well as Newspaper.

Panama (HP)

participants:	50
stations:	5
internet:	10
countries:	6

Scout groups 10 and 94, of the metropolitan area had the opportunity to camp at the wooded grounds of the Panamese amateur radio union. The union made her installations and radio communication services available to us for the second time, writes Eric Macías. On the other side one finds a weather station, and that gave the opportunity to get involved in that one too.

A special thanks to the National Scout Association for the logistic support in bringing participants to the various locations in use.

The participation in the Chiriqui region is always strong as there are many radio amateurs there.

Poland (SP)

participants:	270
stations:	12
internet:	0
countries:	42

Jan Ladno writes us: by tradition the headquarter station SP5ZHP operated from Tosice. For many visitors it was their first contact

on the short wave bands. Many of them were surprised they could talk for so long and it was free; a GSM contact with France costs 3 USD for 3 minutes !

A competition was organised in Rawicz at SP3ZHW, under the name "SP JOTA UKF-2001". Every Scout that could make 44 contacts on VHF or UHF got a special certificate.



Her first contact with the USA....!

Portugal (CT)

participants:	1588
stations:	10
internet:	1
countries:	19

This is one of de best JOTA/JOTI at the last years, to the AEP, writes Celestino Martins; 52 groups, with 1593 Scouts participated at 11 stations a very good opportunity to the Portuguese Scouts to communicate with Scouts in other countries.

CT8AEP, the national station, was installed at the Scout Camp School of Caparica.

Other stations were in Oporto, Algarve, Odivelas, Lisbon, Leça da Palmeira, Guimarães and Azores and a bigger station with 685 scouts in camp was installed at Estorial, near Lisbon.

CUOAEP on the Azores created an envelope with a commemorative postmark.



A 7-year old cub of AEP group 36, said: "I wish for peace in the world and that all people are being friends; may the evil disappear from the earth."



Communication can be simple and efficient: a Scout built Morse code generator.

Slovakia (OM)

participants:	94
stations:	6
internet:	5
countries:	34

Josef Bojanovský reports from Slovakia: the 44th JOTA was an exceptional event for Slovenský skauting - during the weekend when JOTA was happening, the 10th National Assembly of Slovenský skauting took place in Trenčín. Therefore it was clear that setting up a ham radio station within the venue of the Assembly would

be a great idea. Two Scout radio operators, Radovan Vlček OM2ZZ and Andrej Laudis OM1CW prepared all necessary equipment and brought their ham radio station. Their stand was well marked with a large JOTA logo and brought attention of Scouts from the very start of the Assembly. Some problems came up in the beginning, when the radio station's signal interfered with the microphones within the plenary hall. In order to prevent this from happening during the Assembly, the radio station was moved further away from the plenary hall, however still close enough for interested Scouts

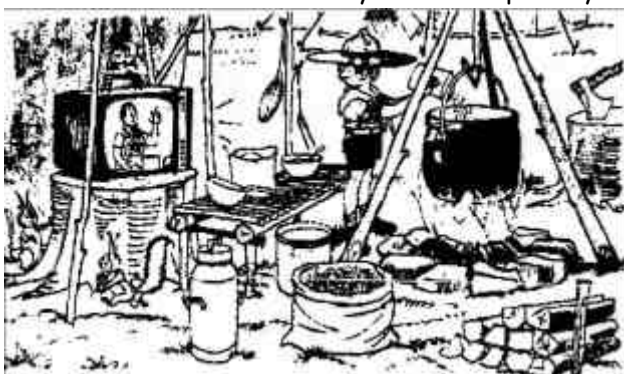

to have a look at it. First successful connections were established with Slovak radio operators, the very first one was Jozef OM5AW from Nitra. A number of other contacts with foreign stations were made in a short while. Curious Scouts and their Leaders could observe transmission of greetings and messages and some twenty of them could try operating the station by themselves. The most interesting contacts were two stations from Japan and 9H1 IHQ from Malta.

Besides Trenčín, a Scout radio station was transmitting from Malacky, a small town in western Slovakia. They managed to make 25 connections. Traditionally, two stations, operated by Scouts from Nové Mesto nad Váhom were brought to the summit of Javorina mountain (970m), the highest peak of a mountain group near their hometown. Another radio station with Scouts sending messages was working at Zelená Voda in western Slovakia.

South Africa (ZS)

participants:	438
stations:	14
internet:	?
countries:	?

Dave Gemmell writes us the following:

ZS1SSB was situated at the Sea Scout Base at Sandvlei, about 15 kms south of Cape Town, on the False Bay coast. This station concentrated on making it a fun weekend for the youngsters for example the best contact was with WX2T oper-

ating for Troop 104. Sea Scout Troop 104 in Wayne New Jersey, was another good contact. The Scouts at ZS1SSB were thrilled to hear and speak to their American counter parts. Radio operator Bud says that the most interesting QSO's were held with K3BSA, 9H3JAM, and GBOJAM. The contact with GXOSCR at Caterham lasted for over an hour, during which time 14 Scouts used the microphone. Their operator Mike G3TWJ was most co-operative and enjoyed the exchanges as much as we all did. Bud was please to report that the Scouts were amazed at the ease with which they contacted 50 stations in the Far East in less that 90 minutes when ZS1SSB suddenly became the cause for a big pile-up! The signals from Korea, Japan, Hong Kong Singapore and Malaysia on 15 metres on Sunday afternoon were quite exceptional.

An annual Scout competition had been arranged at the Hawequas Scout Ranch about 55 kms north-east of Cape Town over the JOTA weekend so it was only natural to site the annual JOTA activities with ZS1HSR (Hawequas Scout Ranch) there as well.

This campsite is set amongst the mountains, which proved a little bad for radio propagation. It was most frustrating for Ozzie and the other hams as they could hear stations to the North, (Namibia, Gauteng and Zimbabwe) working other JOTA stations but they could not raise them. They also heard HB9S and called them but were unable to work this prized station in Geneva!

The station ZS5YG of the Kingsway girl guides in Amanzimtoti, on the KwaZuluNatal coast about 27 kms from south of Durban only operated on Saturday. The weather played up again and we had drizzle most of the time. We are looking forward to a dry JOTA again. ZS5YG made a most interesting QSO with ZS5MU Alaister at Umzumbi. The guides learnt something about the Maritime Net and how ham radio can aid with communications at sea. The guides had a good time on the air, and for a change, they all went on the air. None of the guides had spoken on the air before.

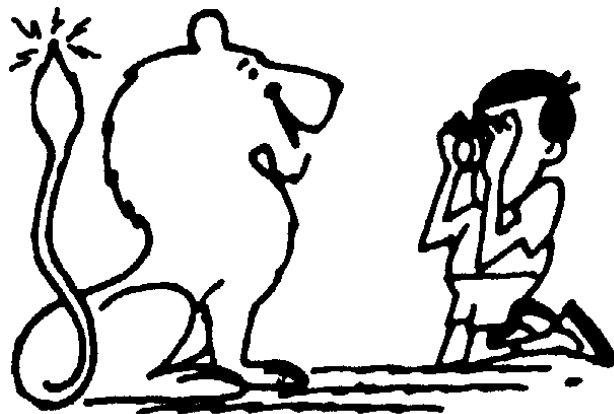

"Ok guys...pull !"

The station, ZS5PBM was at the Guide Camping and Training grounds situated near World's View on a high mountain ridge overlooking Pietermaritzburg. The LED Patrol made the winning logbook for the JOTA activities:

"Today, seeing that it is JOTA after all, we all had a chance to communicate with other Girl Guides. Because we had thunder and lightening, we didn't get a lot of time to talk. The radio amateur told us about the inside parts of the radio, which were, the transistor, the resistor, the transformer, the diode and the L.E.D.s (Light Emitting Diodes) which just so happens to be our patrol names. ZS5PMB was

our station name. We spoke to people in Madagascar, Zimbabwe, Durban, Amamzintoti, Chelmsford Dam and a whole lot more! It was very exciting when we got through to the other girls! I really enjoyed it!"

ZS6BP operated from Arrowe Park, about 20 kms east of Johannesburg. Several hours after the opening of the camp on Saturday morning we were still trying to establish our first HF contact! As part of the plan to ensure that all the Scouts could talk over the radio and be awarded the special 'I Made A Contact badge', we planned to establish a 2 m link with another JOTA station being run at

Delta Park north of Johannesburg but due to some poor 'people' communications, this did not happen. However, in true Scouting spirit another plan was made and John (ZS6RNA) took to the road in his car along with groups of youngsters who were ecstatic at being able to chat with their friends back in camp by using the mobile rig!

For those unfamiliar with SA weather conditions you may be interested to know that here on the Highveld (nearly a mile above sea level) we have one of the highest incidents of lightning strikes in the world and hence it is VERY unwise to continue radio operations once a 'storm' has started! Eventually HF conditions improved (a little) and a number of contacts were made. The most remote being UA9KWB located just inside the arctic circle (Brrrrr!). Although several JOTA stations around the world were heard, we only managed to establish contact with two. ZS3KBS in Kimberly and ZS2JAM in Port Elizabeth. At the close of camp, 44 cub's and Scouts managed to earn the special JOTA badge and virtually every member of the camp staff also chatted over the radio. Even the Area Commissioner paid us a visit and was able to talk with the station in Port Elizabeth!

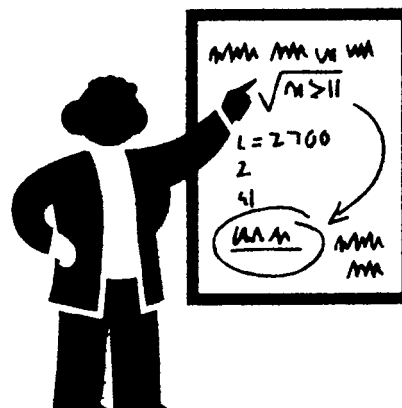

Nigel ZS6RN was happy to say that the primary objectives were achieved: ALL the participants had LOTS of FUN!

Scouts enjoyed a number of bases including amateur radio, Internet workstations, water activities, commando course, orienteering course, electronics construction and a campfire on Saturday evening. There were special 'Challenge' badges awarded to the first 15 to visit and participate in all the bases.

An idea taken from the annual JOTA report was the preparation of a 'Notes Sheet' that the Scouts were able to complete prior to making a contact. This proved to be very effective in eliminating 'mike fright'!

Sudan (ST)

participants:	83
stations:	2
internet:	2
countries:	25

Magdi Osman reports that JOTA was arranged for the 4th time in Cupertino with "SUNA" Sudan News Agency, Dr. Rabea, Eng. Elderdieri, SUNA staff, National Telecommunication Corporation and "SARA" Sudanese Amateur Radio Association Dr. Sid Ahmed "'ST2SA'". Participants were among others Khartoum Sea Scouts,

Khartoum Aeronautical Scouts and Khartoum North Cub Scouts. Most of participants this year were Cub Scouts.



"First you fix the wire here and then....."

Participants could enjoy the radio. The ST2BSS station provided Scouts and visitors to learn how use the radio, talk to other Scouts; Scouts could earn merit badges, a scarf and a certificate of JOTA too. This year we used old portable hand held CB-radios for training Cubs & the boys Scouts.

The general commissioner Dr. Atif and the secretaries general were visiting.

Their most existing tow contact was Mr. Paul. PA3GND from the Scout group of Sluiskil in the Zeeland province. We exchanged information, especially with the

rover crew of the Khartoum Sea Scouts. Hashim & Eltayp explained the water activities like swimming, rowing, canoeing, sailing, life saving, and how to teach the members to protect the Nile Banks

and coastal environment of the Red Sea. After that, they invited the Rover Scouts from Zeeland to join with them on a rowing boats hike from Khartoum Sea Scouts Centre on the river Nile to Atbara Sea Scout Centre, about 325 km north of Khartoum.

Tunisia (3V8)

participants:	70
stations:	5
internet:	0
countries:	25

Under the warm Mediterranean weather, Tunisian Scouts took part in the 44th JOTA for the fifth time. Five Radio Amateur Scout stations were on the air. Scouts from the north to the south were busy learning the newly required skills and enjoyed getting in touch

with Scout friends from different countries. Some of them had never spoken the Shakespeare language, so it was funny hearing them trying their best to use the appropriate words. Because of the unexpected break-down of the headquarter radio station 3V8ST we took the Scouts to another nearby station 3V8CB where they joined their friends.

The JOTA has become a welcome event for the Tunisian Scouts to challenge their mates who have never been there and to exchange experiences.



3V8CB calling from Tunisia.

Turkey (TA)

participants:	1180
stations:	9
internet:	75
countries:	24

We began to work well in advance, says Savas Baran, with our JOTA newsletters. Last year some 500 Scout leaders were trained and some of them were very eager to find out about JOTA.

Again I had the time to walk around Scout JOTA centres in Ankara. An impression:

Onur a 10-year old boy said: "I had the chance to speak on the air the first day. It was really fun to speak to some Scout from another country. We were in the largest shopping centre in Ankara in front of a cashing row. There were thousands of people passing by and looking at us. This was my first experience in JOTA but I had great help from my patrol leader".



"Well, that's great to hear. We have three girls here that want to talk to you..."

A. Gökhan, an 11 year-old Scout: "What an experience. I spoke on the air, made a chat on the internet with Scouts. I ate dry beans. Sang Songs. I want to participate again". (Savas: probably he is the NJO in the 55th JOTA).

Gizem, a 12 year-old Girl Guide: "I began Scouting a year ago. I am responsible for food in our JOTA camp. I like cooking. I was speaking with a Scout leader on the air. He asked, "What is a camp?" I replied: " Camp means eating dry beans". We camped on the

parking lot and had a lot of fun too".

Orcun a 10-year-old Scout said: "I worked hard to memorise the spelling alphabet and calling procedures all first day. At 4 O'clock after midnight I had a chance to call on the air. We had the JOTA as a great family atmosphere with our leaders and friends like sisters and brothers. I will never forget this experience and joy in my life".

Girl Guide Zekiye: "I am very new to Scouting. I really enjoyed sharing joys with Scouts and guides. We camped but everybody was after getting a contact on the air. Some were sleeping on chairs (and getting contacts on their dreams)

Hazar (12 years.) said: "It is really magnificent to speak amateurs and Scouts from other countries. I was responsible for Radio equipment. So I slept just three hours. We even got a contact from North America.

Provinces were also on the air, Kayseri, Eski°ehir, Istanbul, Trabzon, Samsun. There are also new ones too. Adana, Ardahan, Hatay, Denizli.

In Samsun there was a JOTA and JOTI activity in the Youth Centre. Several Scout and guide groups were participated.

Eski°ehir was on the air too. Local TV made news with their activity. They camped in a local village called Sultandere (Soltan's Creek). A seminar was also organized for Scout leaders. Some of them will get their certificates of Amateur Radio soon.

In Istanbul several Scout groups participated from the headquarters. Ardahan has a brand new Scoutmaster who organized the event with his new Scouts and guides.

Scouts planned a camp at Dortyol town in the Hatay Province. But some officials said they couldn't transmit without permission from the National Radio TV Agency. Somebody was wrong but I don't know who! The camp was cancelled.

Camping in a parking lot of a shopping centre and join in JOTA in front of some 150.000 eyes in two days is interesting and a good promotion for Scouting.

One Scout troop ran on the streets to find someone who speaks English to help them with a contact.



United Kingdom (G)

participants:	5430
stations:	128
internet:	0
countries:	49

It was gratifying to see that this year more UK stations took part in JOTA. From the reports it is clear that stations are achieving the main purpose of JOTA - "enabling Scouts to contact other Scouts". Each year I am agreeably surprised by

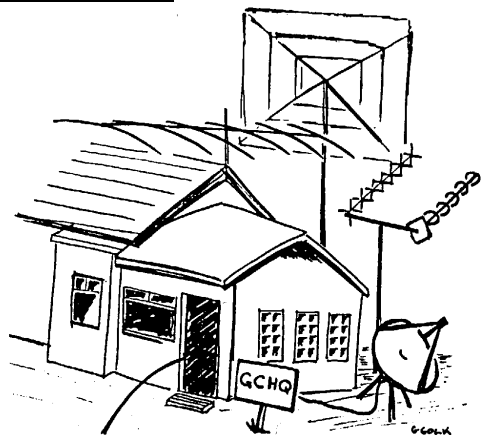

No, no, this is Gilwell Communication Headquarters!

the number of international contacts that are made, writes Richard Gaskell.

In addition to the Scout stations, many others call in with good wishes for a successful JOTA. All the operators seem to have links with Scouting or Guiding either fond memories from their own youth or through other members of their family. One of the most remarkable of these contacts must be that between GBOCAW in Norfolk and the International Space Station, when Scout Leader Chris Rolph G7HXW spoke to Crew Commander Frank Culbertson KD5OPQ, who has links with Scouting.

For many in northern Europe, Sunday was spoiled by the selfish behaviour of contestants in the German Contest.

United States (W)

participants:	5595
stations:	?
internet:	?
countries:	

Ray Moyer presented us an overview of the comments he received from his JOTA participants:

We found that Scouts all over the world do many of the same things. There was a lot of mike fright but once they started it was gone. First time working with Scouts since 1961 and had a great time. A troop from Louisiana talked to Scouts in New Mexico and found that they climb mountains and snow board as part of their Scout program. A troop in Okla-

homa was camping in 20-degree weather while Scouts in New Jersey were camping in 76-degree weather. Fun talking to a Special events station at the Coast Guard base. One Scout talked to another Scout over 2000 miles away and found out that one of their wives had gone to school over 26 years ago near where the other person lived. Show off old equipment and let the Scouts try old receivers and keyers. They really enjoyed the new equipment but the old equipment was fun to use. Worked the International Space Station. A troop in Louisiana tried to talk to Scouts in England but had a very hard time since the Scouts from England could not understand what was being said due to the accents of the Louisiana Scouts. Was able to work Gilwell Park, HB9S and South Pole.

It was a great experience for both the Scouts and the amateurs. Will make event even bigger next year so more Scouts can participate. Setting up a radio merit badge event also so we can move Scouts from one to the other. Want to contact other Scouts from around the world. Had a great time.

Worked Girl Scouts that will be sending pictures. Forgot to hook the wire to the receivers and could not figure out why we were not getting any signal. We had boys in line to operate at 3:30 am.



" CQ Jamboree, CQ Jamboree, this is troop 523 calling...."

This was a very interesting JOTA year, concludes Ray. We had a lot of Scouts participate and request the participation cards and patches but had a very low number of reports turned in. I feel that the happenings of September 11th did affect our participation. We had events scheduled at locations that were restricted and some events were cancelled.

World Scout Bureau (HB9S)

participants:	5
stations:	1
internet:	0
countries:	69

The World Scout Bureau's amateur radio station joined in the 44th JOTA from the Scout centre "les Pérouses", just outside the centre of Geneva. The WSB office itself was being renovated and the Scout Centre provided more space for equipment and antennas.

A 3-element beam on a telescopic mast (kindly installed for us by Robert, HB9DPZ) was quickly mounted as well as dipole antennas for the lower bands. A VHF link to the nearest packet node on top of the Jura Mountains gave us access to the packet-radio network and the DX clusters.

Gerald HB9AJU, Mike M5ACX, Yves HB9AOF and Richard PA3BAR formed this year's operator team.

HB9S enjoyed the perfect conditions that the radio bands offered to the JOTA. This meant less sleep for the operators and more contacts. We made 260 contacts in 69 different countries. "This year could be summarized as better quality than quantity", comments station manager



Your 2001 HB9S team:
fltr: HB9AJU, HB9AOF, PA3BAR and M5ACX

Yves Margot. "We have spent more time with each station and contacted more countries than ever before, surpassing our record of 1999".

More contacts than ever were made with distant Scout stations. We tended to give priority to these stations, as the European ones would be able to contact us anyway during less favourable radio conditions.

We started the weekend by listening to the Dutch JOTA opening broadcast from PA6JAM, in which National Office director Cor Louwse surprised one of the radio team members, Gerard Blonk, with the silver award of Scouting Nederland for all the work he did for the JOTA for many years.



Gilwell Park GB2GP, A47JOTA in Oman, JA1YSS at the Japanese Scout HQ in Tokyo, TF1JAM in Iceland, ST2BSS in Khartoum, YBOS at the Indonesian Scout HQ in Jakarta, BV0BST in Taipei, V5TSB in Tsumeb Namibia and Z27JAM in Harare Zimbabwe were amongst the many JOTA stations we managed to speak to over the weekend.

"...and greetings from all of us here in Geneva...."

Saturday night the 20-m band just wouldn't close. We were still running contacts at 04:00 AM with S-America (in Spanish), whilst the Australians and New Zealanders were calling at the back of our antenna. With the band still open, the eyes of your operator however, had to close for just a few hours.

What a surprise to talk several minutes with a Scout camp in New Zealand, operating a simple transmitter, ZL3CAR, on a ground-plane antenna. And Scouts in Durban, South Africa, transmitting with a 100 Watt from ZS5PMB and a dipole antenna.

Whilst the large beam antenna was running on 20 m, Richard retuned the 40 m dipole to try to work on 15 m. Only to discover that he could contact Japanese and Indonesian stations with very loud signals on just this piece of wire as an antenna. Radio is full of surprises.

We learned of one group who had organised a reversed fox hunt: Scouts had to find a hidden location in the woods, operate there by hand a generator to make enough electricity to put an old AM transmitter on the air. With that, they had to report back to their headquarters.

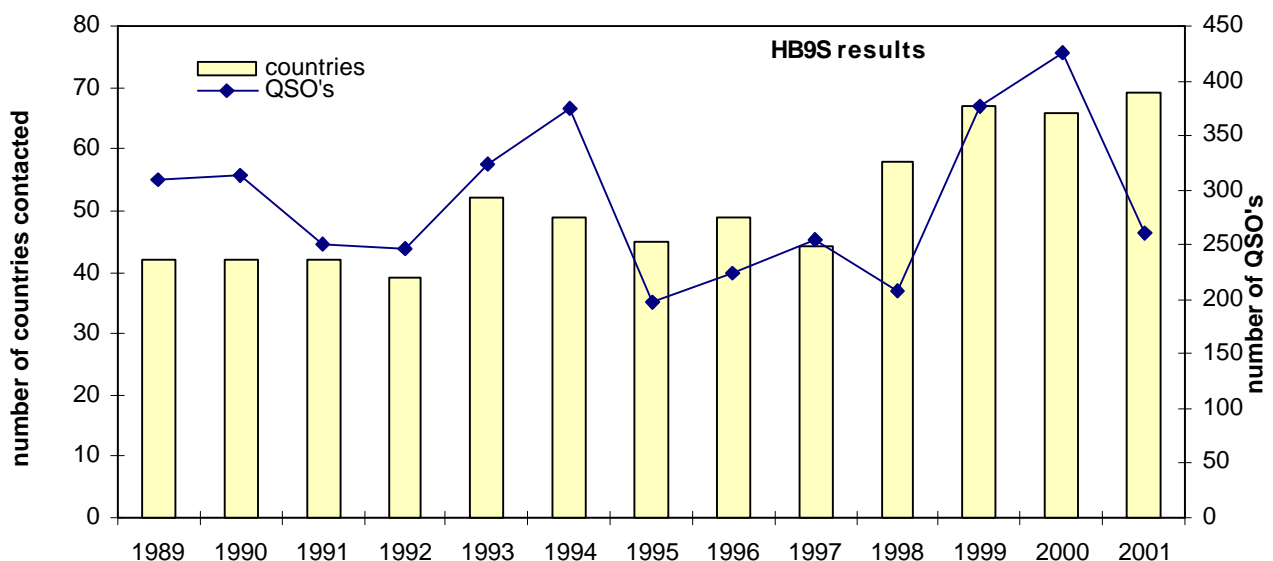

7. Kit corner

We present you the eighth edition of our electronic kit building corner. The intention of this chapter is to provide you with some ideas and suggestions. Many simple circuits that are suitable to build with your scouts can also be found on our web site.

This year's suggestion is a bit more difficult, yet a greater challenge and a wonderful combination of traditional Scout craft and modern electronics:

An electronic compass.

Thanks to Dave Gemmel, NJO of South Africa, for making this schematics available to us as well as the readily built demo model.

How does this work? The compass uses a component that is sensitive to the magnetic field of the Earth: the better it is orientated alongside the Earth magnetic field, the larger the output voltage is. This voltage is amplified and used to steer a line of LED's (light emitting diodes). The effect is simple and effective: as soon as you point North with the compass, all diodes will light up. The more you turn away from North, the less diodes will light.

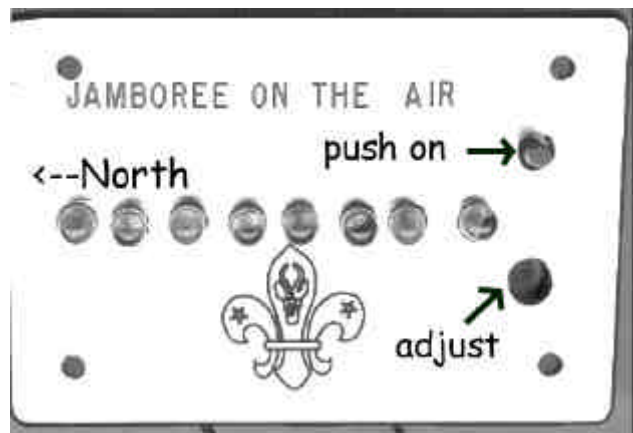

The front panel of the housing has a push button to switch the compass on. A variable resistor is used to adjust all the diodes such that all light up when pointing North. It may be needed to readjust them as battery power gets less in time. The device uses a standard 9 V battery.

The heart of the circuit is the magnetic sensor, in fact there are two. These are Hall elements, Q1 and Q2, and must be placed one facing North and one facing South. The rest of the circuit consists of a voltage regulator, a general purpose amplifier and a led bar driver.

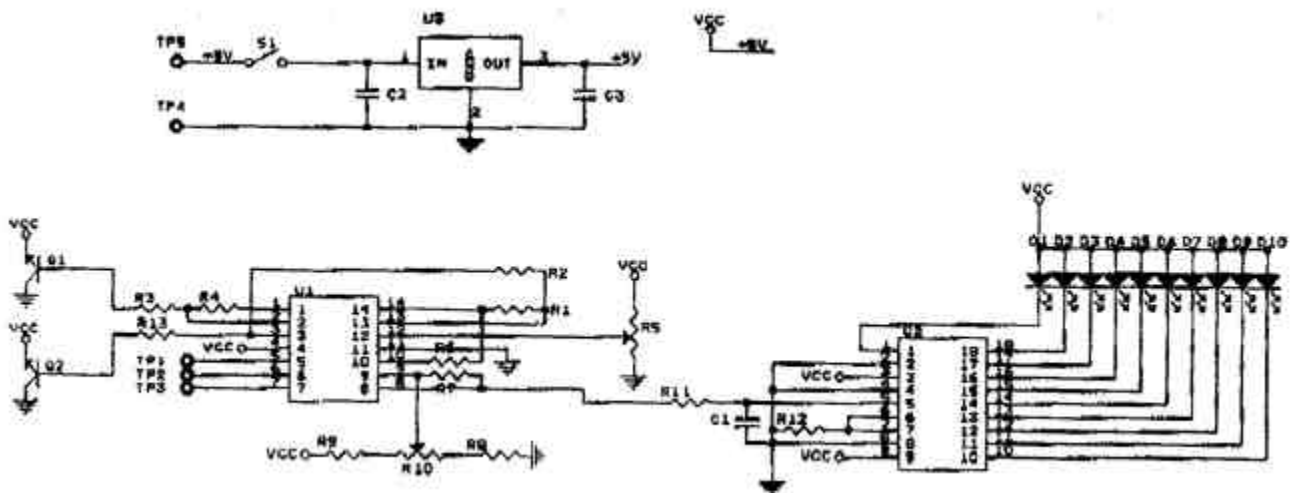

The photograph below shows the double-sided printed circuit board that was made for the demo model. On top the component side that shows you how to place the electronic parts. Below that the "copper" side where the leads are soldered. Unfortunately we do not have a print lay-out drawing, but you may be able to produce one from this photo, taking into account the measurements (in cm).

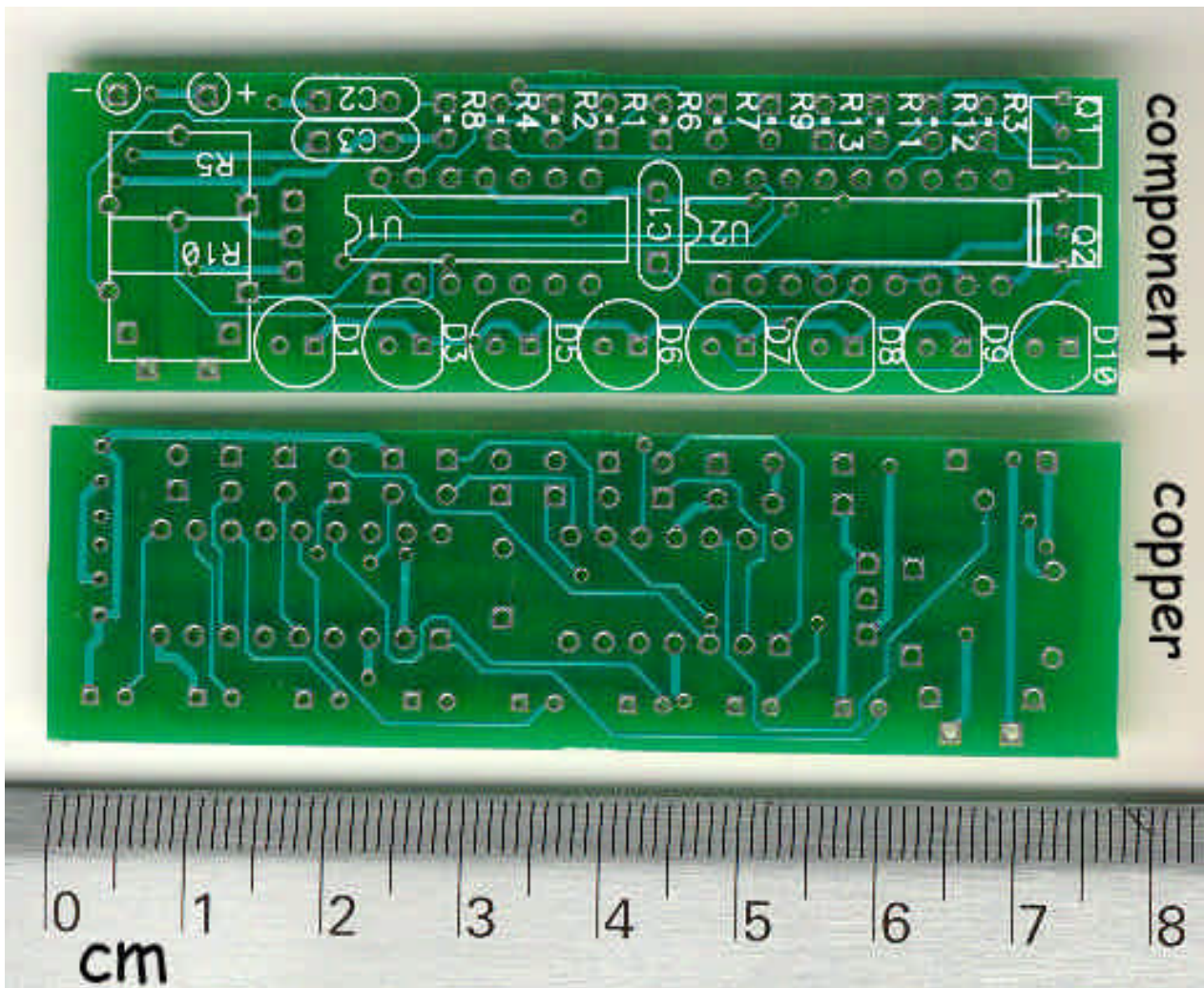

The list of components you need:

- | | |
|---------------------|-----------------------------|
| S1 | push button switch |
| D1 - D10 | standard LED's |
| Q1, Q2 | Hall sensor, type UGN 3503U |
| U1 | LM 324 amplifier |
| U2 | LM 3914 led bar driver |
| U3 | LM7805 voltage regulator |
| R2,R4,R7 | 100 kΩ resistor |
| R3,R6,R8,R9,R12,R13 | 10 kΩ resistor |
| R1,R11 | 470 kΩ resistor |
| R5 | 10 kΩ variable resistor |
| R10 | 1 MΩ variable resistor |
| C1 | 4.7 nF, 10 V capacitor |
| C2,C3 | 100 nF, 10 V capacitor |

Battery clip and leads

9V battery

We leave it up to your fantasy to use your new electronic compass in an exciting Scouts' game !

8. Forthcoming events

During the summer there will again be a number of large (inter) national camps and activities that have a scout amateur radio station on the air. To easily find these stations, scout stations in the European Region are asked to call CQ SCOUT daily during July and August for the universal "summer camp sked":

European Summer Camp sked:
on 7.090 MHz at 07.00 GMT and
on 14.290 MHz at 07.30 GMT

The radio-scouting agenda for 2002:

26 - 28 April		9 th German RdP-radio-scout meeting	Villingen-Schwenningen, Germany
18 - 21 May	OZ1RDP	Whitsun camp Bremer Funkergilde	RØMØ-Island, Denmark.
28 Dec - 8 Jan	E2OAJ	20 th World Scout Jamboree	Sattahip, Thailand.
May 2003		6 th European Radio Scouting Seminar	Burg Rieneck, Germany

For additional last-minute info see www.scout.org/jota

Scout Nets.

Weekly or monthly nets exist in which licensed Scouts meet on the air:

Country	day	time	frequency	netcontrol
Denmark	Saturday	13.00 GMT	3.740 MHz	
European Scout Net	Saturday	09.30 GMT	14.290 MHz	PA3BAR
Germany	1st Sunday of month	16.00 GMT	3.678 MHz	DFOVCP
	3rd Wednesday of month	20.00 local	packet-convers	DBOEAM
Japan	3rd Saturday of month	23.00 local	21.360 MHz	JA1YSS
United Kingdom	Saturday	09.00 local	3.740 MHz	G4PSG
Netherlands	Saturday	19.00 local	3.740 MHz	PI4RIS
Norway	Saturday	15.30 local	3.740 MHz	
Sweden	Saturday, even weeks	15.00 local	3.740 MHz	
United States	Sunday	20.30 GMT	14.290 MHz	K2BSA

Since many years, scout stations have used the frequencies below to easily find each other on the bands.

World Scout Frequencies:

band	phone (MHz)	cw (MHz)
80 m	3.740 & 3.940	3.590
40 m	7.090	7.030
20 m	14.290	14.070
17 m	18.140	18.080
15 m	21.360	21.140
12 m	24.960	24.910
10 m	28.390	28.190



9. The 45th JOTA

45th Jamboree-On-The-Air, 19 - 20 October 2002.

The logo for the 45th JOTA, is shown on this page. It is a design following an idea of 12-year-old Scouts Jorge Rojas and Jacobo Olave of the Sagrada Familia Chilena group in Santiago, Chile.



Look for this information:

The following information will be mailed on paper to all Scout Associations as well as emailed directly to those National JOTA Organizers listed in chapter 10.

July/August 2002:

the JOTA information circular with proposed theme activities, programme suggestions, the latest JOTA news, the operating frequencies and a report form for national use. With this mailing the participation cards will also be send.

February 2003:

The electronic version of the World JOTA Report will be available for download from the web site.

May 2003:

the printed World JOTA Report (WSB ref.nr 1310) will be there again. Extra copies can always be ordered directly from the World Scout Bureau, on-line at the web site of SCORE, the world scout shop: www.worldscoutshop.org. Look in the radio-scouting section.

The WOSM web site for JOTA information, www.scout.org/jota, is updated at regular intervals and carries the actual JOTA information already from April onwards.

In addition, the circular is also uploaded to the "scouts@WW" and "jota@WW" sections of packet-radio bulletin boards at regular times. Check your own packet-radio mailbox server station.

10. National JOTA Organizers

-
- World JOTA organizer** : Mr. Richard Middelkoop, Cornelis van Ramshorstlaan 13,
NL-3863 AZ Nijkerk, The Netherlands;
packet: PA3BAR@PI8UTR email: RMiddelkoop@world.scout.org.
- HB9S station manager** : Mr. Yves Margot, 7 Rte.A. Ferrand, CH-1233 Lully, Switzerland;
packet: HB9AOF@HB9IAP email: hb9aof@uska.ch.
- World Scout Bureau** : P.O. Box 241, CH-1211 Geneva 4, Switzerland.
-

This list contains the names of the active National JOTA Organizers (NJO), i.e. those who have sent reports to the World Scout Bureau at least once during the past two years. Packet-radio- and email addresses have been added where known to us. Information on JOTA is sent directly to the NJO's below and is also sent to the International Commissioner of every Scout Association as well as to the World and Regional Scout Committees.

- Australia** : Mr. Stephen Watson, VK4SGW, 39 Swales St, Mundingburra, QLD 4812.
Email: jota.joti@scouts.com.au.
- Austria** : Mr. Walter Nowakowski, OE1WN, Fröbelgasse 46/18, A-1160 Wien. Email: BBPAF@ppoe.at.
- Azerbaijan** : Mr. Namik Jafarov, 98A Fatali Khan Khoyski Str., Baku 370072. Email: azeriscout@azdata.net.
- Bangladesh** : Mr. Aminul Kawser, S21D, 70/1 Purana Paltan Line, Inner Circular Road, Kakrail, Dhaka 1001.
Email: esc@agni.com.
- Bolivia** : Mr. Juan Carlos Valdivia Cox, Casilla postal 3093, Cochabamba. Email: fhancarlo@hotmail.com.
- Canada** : (SC) Ms. Lena W. Wong, Scouts Canada, 1345 Baseline Road, Ottawa, Ontario K2C 0A7.
Email: lwong@scouts.ca.
(ASC) Ms. Julie Lefebvre, Centre National, 7679 avenue Papineau, Montreal, Quebec, H2E 2H1.
Email: com_prog_jeunes@asc.ca.
- Chile** : Mrs. Isabel Carreño Arellano, CE3TLE, Av. Ejercito 177, Casilla 21113, Santiago 21.
Email: CE3TLE@hotmail.com.
- Croatia** : Mr. Vladimir Jurkic, 9A1ACD, Pino Budicin 31, HR-52100 Pula. Email: tjurkic@hotmail.com.
- Cyprus** : Mr. Erricos Lanitis, 5B4GJ, P.O.Box 40216, Larnaca 6302. Email: erricosphotold@cytanet.com.cy
- Czech Rep.** : Mr. Hana Konvicka, OK1TMP@OKOPPR, Malenicka 1791, CZ-14800 Praha 4.
Email: knihovna@htf.cuni.cz.
- Denmark** : Mr. Brian Lodahl, OZ2BRN, Sonjavej 42, 1A, DK-9000 Aalborg. Email: brianlodahl@kfumscout.dk.
- Finland** : Mr. Markus Hamro Drotz, OH2KMT, Siirinkuja 2, FIN-02700 Grankulla. Email: oh2kmt@sral.fi.
- Germany** : (DPSG) Mr. Klaus D. Sperling, DC4NA@DB0BOX, Leharstrasse 8b, D-90453 Nürnberg 60.
(VCP) Mr. Günter Erdmann, DL9BCP@DB0VER, Wecholderstrasse 59, D-28277 Bremen.
Email: gerdmann@gmx.de.
(BdP) Mr Lars Weimar, DG4SEV@DBOULM-8, P.O-Box 1116, D-89130 Blaustein.
Email: meikapu@weisse-rotte.de
- Greece** : Mr. Costas Theologis, SV1SEP@SV1BDS, 1 Ptolemeon street, GR-11635 Athens.
Email: Int-sep@otenet.gr.
- Hong Kong** : Scout Amateur Radio Club, 10/F Hong Kong Scout Centre, 8 Austin Road, Kowloon.
- Iceland** : Mr. Konrad Thorisson, TF3KET@TF3NOS, Gardaflot 7, 210 Gardabaer. Email: konth@skima.is.
- Indonesia** : Mr. James Darmawan, YBOBEN, Kwartir Nasional Gerakan Pramuka Jl. Medan Merdeka Timur 6
Jakarta 10110. Email: james.darmawan@britishcouncil.or.id
- Ireland** : Pat Geoghegan, EI9EZ@EI2HH, 24 Shanbally, Cappoquin, Co Waterford. Email: geoghegan@iol.ie
- Italy** : Mr. Sandro Naspi, IW0FJQ, Via del Pianeta Terra 23, I-00144 Roma. Email: naspi@tiscalinet.it.
- Japan** : Mr. Toichiro Nishiyama, JA1OBY, No.11-10, 4-chome, Osawa, Mitaka-shi, Tokyo 181-0015.
Email: saj@scout.or.jp.
- Luxemburg** : Mr. Claude Engel, LX1VW, 50 rte de Boudersberg, L-3428 Dudelange. Email: claude.engel@ci.educ.lu
- Malaysia** : Mr. Tan Sow Sung, 36 Lorong Nangka 5, Taman desa Damai, 14000 Bukit Mertajam.
Email: skks@pd.jaring.my.

- Mexico** : Mr. Xochitl Prado Serrano, 4C1ASM, Cerro Compostela #10, Col. Campestre Churubusco, C.P. 04200 México D.F. E-mail: xochitlprase@hotmail.com
- Namibia** : Mr. Jim Kastelic, P.O. Box 228, Tsumeb. Email: kastelic70@yahoo.com.
- Neth. Antilles** : Mr. Hubert Martha, PJ2SA, Kaya Araña 93, Romar Estate, Curaçao. Email: Hubertmartha@hotmail.com.
- Netherlands** : Mr. Jan Kluiver, PBOAMJ, Lallemanstraat 18, NL-2841 CD Moordrecht. Email: PBOAMJ@Amsat.org.
- New Zealand** : Mr. Jim Parnell, ZL2APE, 87 Duncan Terrace, Kilbirnie, Wellington 6003. Email: jim-p@ihug.co.nz.
- Nigeria** : Rev. O.S. Adetunji, The Scout Association Of Nigeria, 1, Makoko Road, Yaba, P.O.Box 429, Yaba, Lagos.
- Norway** : Mr. Dag Anders Kjærnes, Ravnaasveien 87, N-1254 Oslo. Email: dagak@online.no.
- Oman** : Mr. Dawood Nadhar Al-Zadjali, A41JX, National Organisation for Scouts and Guides, P.O.Box 1528, PC 112 Rewi. Email: omnscout@omantel.net.om.
- Panama** : Mr. Eric A. Macias, HP1EAM, Bethania Calle 67 final, 6-8783 El Dorado Panamá. Email: eamaciasz5@hotmail.com.
- Peru** : Mr. Luis Hinojosa Pacheco, Av. Arequipa 5140 Miraflores, Lima 18. Email: jotayjoti@latinmail.com.
- Poland** : Mr. Jan Ladno, SP5XM, ul. Nowolipki 10 m 80, PL-00-153 Warszawa.
- Portugal** : (CNE) Mr. José Augusto Marques Joaquim, CT1EHZ, Rua Dom Tristao Vaz Teixeira no. 5 - 2º, Frente, P-2675-601 Odivelas.
(AEP) Mr. Manuel Celestino dos Santos Martins, CT1ASU, Av. Combatentes de Grande Guerra, Bl.5 3e esq. P-8700-440 Olhão. Email: ct1asu@hotmail.com..
- Romania** : Mr. Nicolae Draguleanu, YO3CZ, Aleca Porana Mare 6, bloc B 8/47, seet 6, 77308 Bucuresti. Email: draguleanu@pcnet.ro.
- Slovakia** : Mr. Josef Bojanovsky, OM3OF, Kosikarska 14 / 1431, 915 01 Nove Mesto nad Vahom.
- Spain** : Scouts de Aragón ASDE, Fernando de Antequera 2, E-50006 Zaragoza.
Grupo Scout Severo Montalvo ASDE, P.O. Box 148, E-30880 Aguilas. Email: ciadj@ceta.es.
- South-Africa** : Mr. Dave Gemmell, ZS6AAW, P.O. Box 77, Irene 0062. Email: davegemmell@bmknet.co.za.
- Sri Lanka** : Mr. V. Gunaratnam, 457RS, 65/9 Sir C. A. Gardiner Mawatha, Colombo 2. Email: slscouts@sltnet.lk.
- Sudan** : Mr. Magdi Osman Ahmed, ST2BSS, Airport-P.O.Box 2, 11112 Khartoum. Email: ST2BSS@hotmail.com .
- Switzerland** : Mr. Jürg Herbeisen, HB9JAM, Postfach, CH-3000 Bern 7. Email: jota@pbs.ch.
- Trinidad** : Mr. Mervijn O'Neil, 9Y4TT, 7 Grasshopper Lane, River estate, Diego Martin. Email: ttscouts@hotmail.com.
- Tunesia** : Amaster radio club, 3V8ST, BP 339, Tunis Mahrajen 1002. Email: scout.tunisien@planet.tn.
- Turkey** : Mr. U. Savas Baran, Define S 2/11, TU-06490 A. Ayranci Ankara. Email: bsavas@marketweb.net.tr.
- United Kingdom** : Mr. Richard Gaskell, G0REL, 18 Woodcroft, Kennington, Oxford OX1 5NH. Email: G0REL@care4free.net
- United States** : Mr. Ray Moyer, WD8JKV, P.O. Box 152079, Irving, Texas 75015-2079. Email: rmoyer@netbsa.org.



-----stop press-----stop press-----stop press-----stop press-----

The following JOTA stories arrived after we finished editing this World JOTA Report:

The Scouts de Aragon ASDE group in **Spain (EA)** notified us of their participation with 1 station and 1 Scout!

From **Thailand (HS)** comes the news that October is the closing month for all Thai schools, so it was difficult to assemble the Scouts since Scouting is part of the school system.



The official JOTA station was set up in Satit Bangna School, Samuthprakarn province, whilst there were 6 other JOTA stations running too. Chimkul Scout camp, Saraburee province with Scouts and guides from Wat Hua Chang and Payayen Wittaya school. Benjamaraja nursery school Bangkok, Satit Kasetsart school Bangkok, Dongkui Wittayakarn school Pechaboon, Bodindharadeja school Bangkok and Don Bosco School UdornThani Province.

The opening ceremony was presided by Ms. Raweewan Maisapol, Deputy Director of Satit Bangna School. Several activities

arranged for the scouts and guides. The scouts and guides learned Morse Code very fast. After explaining them the difference between dot and dash we sent out Morse Code by shaking hip [Left - dot, Right - dash] the scouts/guides read it out loud with laughter. Then they were having fun sending it. After their own Morse code oscillators were built, they learned to send by hands and read my ears.. You should have heard it when 30-50 oscillators beeped here and there all the time. But every faces shone with a smile.



The scouts/guides did like electronic kits building. We had to force them to go for lunch with a promise that they could come finishing it after eating.

Fox hunting was our very special activity. In the afternoon, each group was given a handy, a Morse code chart and was assigned to look for a secret code from a specific transmitter, take the code back to the starting point and send the code in Morse. One group ran around, turning their back to the tree, realizing that the fox was somewhere nearby. They ran 3 rounds and finally found that the fox was sitting right under the tree, smiling to them!



But the most impressive activity for the scouts/guides was the fire and rescue. Our hams that are fire & rescue volunteer brought the fire engine fully equipped. The scouts/guides were allowed to take a ride on the fire engine, practicing with water and rescue equipment. One of the scouts made a phone call home right after that, shouting "Mother, they let me spray the water from the fire engine!" Another half an hour later he called again "Mother, did you see me riding the fire

engine!?!?"

Participation of 2 Scouts was also noted from **Hungary (HA)**. Some of the 5000 participants in **India (VU2)** were luckily to have a radio chat with the UN Headquarters. Different states like Mumbai, Chennai, Lucknow and Kerala were on the air. Talking to foreign Scouts was an adventure for them.



World Scout Bureau / Bureau Mondial du Scoutisme
P.O. Box 241, CH-1211 Geneva 4, Switzerland
email: JOTA@world.scout.org
<http://www.scout.org/jota>